



## Table of Contents



### Certification Agencies and Markings



### Circuit Wiring Diagrams

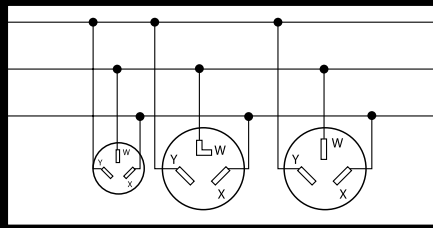

### Electrical Symbols and Abbreviations

- ◻ Push Button    ◻ Buzzer
- ◻ Bell    ◊ Annunciator
- ◀ Outside telephone
- ◻ Interconnecting telephone
- ◻ Telephone switchboard
- ⊕ Bell ringing transformer
- ◻ Electric door opener

Product	Page
Product Standards and Installation Codes	Tech-2
Certification Agencies and Markings	Tech-4
Industry Associations, Organizations and Standards	Tech-5
Codes and Standards Organizations	Tech-6
AC Switch Data and Horsepower Explanation	Tech-7
Wiring Device Standards and Testing	Tech-8
RoHS, WR, TR and LED Power Descriptions	Tech-10
NEMA and IEC Classifications - Enclosures	Tech-11
IP Code and Their Meanings	Tech-11
Enclosure Types for Self-Certified Non-Hazardous Locations	Tech-12

Product	Page
Circuit Wiring Diagrams	Tech-14
Horsepower Ratings for NEMA Configurations	Tech-19
UL 508A Table SB4.1	Tech-19
Isolated Ground Story	Tech-20
Decimal Equivalents Table	Tech-21
Electrical Symbols and Abbreviations	Tech-22
Diameter Ranges of Jacketed Cord and Wire Charts	Tech-23
IEC Pin and Sleeve Terminal Identification	Tech-24
Horsepower Ratings for IEC Pin and Sleeve	Tech-25
Network Cabling Requirements	Tech-26



## Product Standards and Installation Codes

Standards and codes of many types developed by and for our industry form a vital consideration in the design of our products. The following pages in this section briefly describe the functions of the organizations producing the standards which influence the safety and design of wiring devices.

**The American Boat and Yacht Council Inc. (ABYC)** is a not-for-profit membership organization that has been developing and updating the safety standards for boat building and repair for over 50 years. ABYC is actively involved with the International Organization for Standardization (ISO) and is a leader in education for the marine industry, as well as certification programs for marine technicians. ABYC's membership includes boat builders, boat owners, surveyors, boat yards, insurance companies, law firms, trade associations, marinas, dealerships, government agencies, educational institutions and equipment and accessory manufacturers. Over 400 volunteers donate time, expertise, and research while serving on technical committees, which develop and revise the ABYC standards and technical information reports. We ensure quality and professionalism in each of ABYC's services.

**UL LLC, formerly Underwriters Laboratories Inc. (UL)** A for-profit corporation, operating in two distinct roles, as a certifier and testing facility, and as a developer of safety standards. By its own definition, Underwriters Laboratories defines itself as follows: "Underwriters Laboratories Inc. founded in 1894, is chartered as a not-for-profit organization without capital stock, under the laws of the state of Delaware to establish, maintain, and operate laboratories for the examination and testing of devices, systems and materials to determine their relation to hazards to life and property." On January 1, 2012, UL moved to a for-profit structure.

Separate from product certifications, UL develops consensus safety standards for the U.S. UL evaluates products for paying "clients" and if the product submitted passes the requirements of the UL standard for which it is submitted, a UL "Listing" is granted which allows the manufacturer to use the UL manifest or "Label" on its products. Electrical inspectors or other Authorities Having Jurisdiction (AHJs) use UL Listings of products to determine acceptability of electrical installations. It is important to remember that UL is not an approval agency. It approves nothing, but lists a product as meeting minimum standards for safety. The Underwriters "Listing" mark on a product is generally accepted by the public and government agencies as evidence of a "safe" product, not necessarily a "quality" product.

**CSA Group, formerly Canadian Standards Association (CSA)** is a not-for-profit membership-based association and performs a function for manufacturers similar to that performed in the USA by Underwriters Laboratories Inc. (UL) and National Fire Protection Association (NFPA). CSA Standards develops product safety standards for Canada, which parallel UL standards in many aspects but are not always identical. CSA International evaluates products and grants paying clients "Certification" that their products meet CSA Standards. CSA Standards also sponsors the Canadian Electrical Code (CE Code).

**American National Standards Institute, Inc. (ANSI)** as the voice of the U.S. standards and conformity assessment system, the American National Standards Institute (ANSI) empowers its members and constituents to strengthen the U.S. marketplace position in the global economy while helping to assure the safety and health of consumers and the protection of the environment.

The Institute oversees the creation, promulgation and use of thousands of norms and guidelines that directly impact businesses in nearly every sector: from acoustical devices to construction equipment, from dairy and livestock production to energy distribution, and many more. ANSI is also actively engaged in accrediting programs that assess conformance to standards – including globally-recognized cross-sector programs such as the ISO 9000 (quality), ISO 14000 (environmental) and ISO 17025 (laboratory) management systems.

**The International Electrotechnical Commission (IEC)** is the leading global organization that prepares and publishes international standards for all electrical, electronic and related technologies. These serve as a basis for national standardization and as references when drafting international tenders and contracts. Through its members, the IEC promotes international cooperation on all questions of electrotechnical standardization and related matters, such as the assessment of conformity to standards, in the fields of electricity, electronics and related technologies.

IEC's international standards facilitate world trade by removing technical barriers to trade, leading to new markets and economic growth. Put simply, a



## Product Standards and Installation Codes

component or system manufactured to IEC standards and manufactured in country A can be sold and used in countries B through Z. IEC's standards are vital since they also represent the core of the World Trade Organization's Agreement on Technical Barriers to Trade (TBT), whose 100-plus central government members explicitly recognize that international standards play a critical role in improving industrial efficiency and developing world trade.

### **The National Electrical Code® (NEC®)**

The NEC is a model installation code developed by NFPA's Committee on the National Electrical Code®, which consists of 19 Code-Making Panels and a Technical Correlating Committee. Work on the NEC is sponsored by the National Fire Protection Association (NFPA). The NEC is approved as an American National Standard by the American National Standards Institute (ANSI). It is formally identified as ANSI/NFPA 70. The NEC must be adopted locally by legislation or regulation.

First published in 1897, the NEC is updated and published every three years. The 2017 edition will be published in October 2016. Most states adopt the most recent edition within a couple of years of its publication. As with any "uniform" code, a few jurisdictions regularly omit or modify some sections, or add their own requirements (sometimes based upon earlier versions of the NEC, or locally accepted practices). However, the NEC is the least amended model code, even with it setting minimum standards. No court has faulted anyone for using the latest version of the NEC, even when the local code was not updated to the most recent edition.

**National Electrical Manufacturers Association (NEMA®)** An organization of over 450 manufacturers of electrical equipment, including, but not limited to, wiring devices, wire and cable, conduit, load centers, pressure wire connectors, circuit breakers, fuses, etc. NEMA is the "voice" of the electrical industry, and through it, standards are developed for electrical distribution.

Generally these standards promote interchangeability between products of one manufacturer with like products made by another manufacturer. In some cases, standards relating to product "performance" are also formulated by NEMA but these are the exception rather than the rule.

NEMA standards are not compulsory, but generally are accepted by those manufacturers that help to write them as a way of making their products more saleable and acceptable. However, many NEMA

standards, such as ANSI/NEMA WD 6, are approved by the American Standards Institute and referenced by mandatory UL and CSA product standards. NEMA standards are utilized by many consumers in writing specifications for the materials they purchase. NEMA does not evaluate or certify products or enforce regulations.

**General Services Administration Federal Supply Service (GSA) Federal Supply Service (FSS)** provides federal customers with the products, services, and programs to meet their supply, service, procurement, vehicle purchasing and leasing, travel and transportation, and personal property management requirements. Hubbell offers devices listed by UL as FED SPEC and can be found throughout this catalog.

**Occupational Safety and Health Administration (OSHA)** is a branch of the US Department of Labor which was created to assure safe and healthful working conditions for working men and women. OSHA uses regulations from the Federal Register, NFPA and the National Electric Code to establish and enforce safety standards for the workplace. It is important to note: OSHA does NOT approve products. OSHA enforces existing safety regulations.

### **Canadian Electrical Code, Part I (CE Code)**

The CE Code is a model installation code developed by the Committee on CE Code, Part I, composed of members representing inspection authorities, manufacturing and utilizing industries, utilities and allied interests. The Committee meets annually to address reports submitted by 43 section subcommittees. Work on CE Code, Part I is sponsored by CSA Standards. The product standards of CSA Standards comprise the Canadian Electrical Code, Part II.

First published in 1927, the CE Code, Part I, is updated and published every three years, prior to 2006 every four years. The 2012 CE Code, Part I, is the latest edition. As with any "uniform" code, provinces and a few jurisdictions regularly modify or add their own requirements.

**NSF International, formerly National Sanitation Foundation (NSF)** NSF International is a not-for-profit organization founded in 1944 from the University of Michigan's School of Public Safety. NSF develops public health standards, and provides and enforces certifications to protect food, water, and beverages. NSF is the leading certifier of food service equipment.











## Certification Agencies and Markings

### Understanding Certification Marks:

Certification marks vary significantly with respect to testing required to achieve a particular mark. In some cases, (i.e.: Specification Grade), no outside certification agency is involved. The manufacturer decides which of their products they wish to be so identified. The following table for 15 and 20A Straight Blade receptacles demonstrates these wide differences. The understanding of these marks permits the user/specifier to make more meaningful product selections.

Understanding Product Certification Marks - 15 and 20 Amp Straight Blade Receptacles  
Products that carry certification marks must meet the specific testing standards indicated

Certification Mark	Description	UL 498	CSA, C22.2 No. 42	UL 498 Hospital Grade	CSA, C22.2 No. 42 M Hospital Grade	DESC WC596
<b>Spec Grade*</b>	Self Certified, No Testing Required- Advertising/Trade Name					
	Used on recognized component parts that are part of a Listed product or system intended for the United States. Component "C" intended for Canada. Recognized components are intended only for installation by Original Equipment Manufacturers (OEMs) within their Listed products, and are not accepted by electrical inspectors for general-use field installations due to limitations called Conditions Of Acceptability (COA).	X				
	Used on recognized component parts that are part of a Listed product or system intended for the United States and Canada. Recognized components are intended only for installation by Original Equipment Manufacturers (OEMs) within their Listed products, and are not accepted by electrical inspectors for general-use field installations due to limitations called Conditions Of Acceptability (COA).	X				
	Products found with this mark means Underwriters Laboratory or CSA International found that representative samples of this product met Underwriters Laboratory's published Standards for Safety intended for the US market.	X				
	Products found with this mark are certified primarily for the Canadian market.		X			
	Products intended for US and Canada.	X	X			
 • Hospital Grade	In addition to complying with general use requirements, this mark denotes these device have been specially designed and are subject to additional requirements of the standards.	X		X		
 • Hospital Grade	In addition to complying with general use requirements, this mark denotes these device have been specially designed and are subject to additional requirements of the standards.		X		X	
 Fed. Spec.	In addition to complying with general use grade requirements, this mark denotes receptacles also have been investigated for compliance with United States Federal Specification W-C-596.	X				X
 Fed. Spec. • Hospital Grade	In addition to complying with general use and hospital grade requirements, this mark denotes receptacles also have been investigated for compliance with United States Federal Specification W-C-596.	X		X		X

Note: \*Includes such variation as Premium Spec, Super Spec, etc.  
\*\*End Product test also required.

### Cross Reference Note:

Recognize that cross reference guides supplied by some manufacturers should be used only to determine compatible devices (rating and configuration). It does not, in any way, deal with performance levels (which will vary widely by manufacturer). Common catalog numbers are often used for convenience of selection. The use of the same catalog number is solely the discretion of the manufacturer. It in no way implies compliance to any standard or testing criteria.



## Industry Associations, Organizations and Standards

For convenience, the following listings define common acronyms for a variety of organizations.

### Standards Development Organizations: Organizations primarily involved in the development and/or promulgation of standards.

ANSI	American National Standards Institute.
CANENA	Consejo de Armonizacion de los Naciones de America.
CSA	Canadian Standards Association.
IEC	International Electrotechnical Commission.
IEEE	Institute of Electrical & Electronics Engineers, Inc.
ISA	The Instrumentation, Systems and Automation Society.
ISO	International Organization for Standardization.
LEEDS	Leadership in Energy and Environmental Design.
NFPA	National Fire Protection Association, Inc.
NSF	National Sanitation Foundation.
SAE	Society of Automotive Engineers.
SME	Society of Manufacturing Engineers.
USGBC	United States Green Building Council.
UL	Underwriters Laboratories Inc.



### Installation Codes

CEC Part I	Canadian Electrical Code, Part I.
NEC®	National Electrical Code®.
NOM	Normas Oficiales Mexicanas (Mexican Electrical Code).



### Industry Associations: Associations of companies or individuals for the purpose of standardization, trade, and professional development, etc.

ABYC	American Boat and Yacht Council.
ASTM	American Society for Testing and Materials.
BICSI	Building Industry Consulting Services International.
BOMA	Building Owner Management Association.
CANAME	Camara Nacional de Manufacturas Electricas.
CEMRA	Canadian Electrical Manufacturers Representative Association.
ECOC	Electrical Contractors of Canada.
EF-C	Electro-Federation-Canada.
EIA	Electronic Industries Alliance.
EPRI	Electric Power Research Institute.
IAEI	International Association of Electrical Inspectors.
IECI	Independent Electrical Contractors International.
IFMA	International Facilities Management Association.
NAED	National Association of Electrical Distributors.
NAW	National Association of Wholesalers.
NECA	National Electrical Contractors Association.
NEMA	National Electrical Manufacturers Association.
NEMRA	National Electrical Manufacturers Representatives Association.
NMDA	National Marine Distributor Association.
NMRA	National Marine Representative Association.
SEMI	Semi Conductor Equipment and Material International.
TIA	Telecommunication Industry Association.







## Codes and Standards Organizations

For convenience, the following listings define common acronyms for a variety of organizations.

**Certification Agencies:** Primarily involved in certification of products or manufacturers to standards developed by the certification agency or by others.

ANCE	National Association of Normalization and Certification of the Electrical Sector.
BSI	British Standards Institute.
CE	Self Certification Marking of European Community.
CCC	China Compulsory Certification.
CSA	Canadian Standards Association or CSA International.
FM	Factory Mutual.
NRTL	Nationally Recognized (by OSHA) Testing Laboratory.
PSE	Product Safety Electrical Appliance and Material (Japan).
TÜV	TÜV Rheinland of N.A., Inc.
UL	Underwriters Laboratories Inc.
VDE	Verband Deutscher Elektrotechniker (Germany).



Note:  Hubbell products are in the process of being certified in Mexico. Many have already been certified. Consult with the factory for specific data.

## Government Agencies

DSCC	Defense Supply Center – Columbus.
EU	European Union.
FCC	Federal Communications Commission.
IAPA	Industrial Accident & Prevention Association (Canada).
OSHA	Occupational Safety and Health Administration.

Copies of standards referred to on the preceding pages may be purchased from the following:

**American Boat and Yacht Council, Inc. (ABYC)**  
613 Third Street, Suite 10  
Annapolis, MD 21403  
USA

**The American National Standards Institute (ANSI)**  
25 West 43rd Street,  
(between 5th and  
6th Avenues), 4 floor  
New York, NY 10036

or

1819 L Street, NW  
(between 18th and  
19th Streets), 6th floor  
Washington, DC 20036  
USA

**CSA Group (CSA)**  
178 Rexdale Boulevard  
Toronto, Ontario  
M9W 1R3  
CANADA

**National Electrical Manufacturers Association (NEMA)**  
1300 North 17th Street  
Rosslyn, VA 22209  
USA

**National Fire Protection Association (NFPA)**  
1 Batterymarch Park  
Quincy, MA 02169-7471  
USA

**NSF International (NSF)**  
789 North Dixboro Road  
Ann Arbor, MI 49105  
USA

**The International Electrotechnical Commission (IEC)**  
IEC Central Office  
3, rue de Varembé  
P.O. Box 131  
CH - 1211 GENEVA 20  
Switzerland

**Asociacion Nacional de Normalizacion y Certificacion del Sector Electrico A.C. (NOM – ANCE)**  
Ibsen No.13,  
Colonia Chapultepec Polanco,  
C.P.11560 México, D.F.,  
Conmutador 5280-6775

**Occupational Safety and Health Administration (OSHA)**  
Occupational Safety & Health Administration  
200 Constitution Avenue, NW  
Washington, DC 20210  
USA

**UL LLC (UL)**  
Underwriters Laboratories Inc.  
333 Pfingsten Road  
Northbrook, IL 60062-2096  
USA



## AC Switch Data and Horsepower Explanation

### AC Test Requirements

When AC general use switches were considered by the industry and Underwriters' Laboratories, Inc. thought was given to the ratings and it was decided to rate the switches in accordance with NEC branch circuit ratings of 15, 20 and 30 amperes. It was also decided to test the switch for all the loads that could be applied to a branch circuit. Therefore, all AC switches are tested on resistance, tungsten lamp and inductive loads to 100% of switch rating.

### Underwriters' Laboratories and Canadian Standards Association Test requirements for AC General Use Switches

In order to be listed by Underwriters' Laboratories, Inc. and certified by CSA International, all 15, 20 and 30 amperes 120/277V AC switches must perform, without failure, the following sequence of tests.

1. An overload test of 100 cycles at 4.8 times rated current and 40-50% power factor and rated voltage. This overload test is performed at 144 amps, 277 volts for 30 ampere switches at 6-10 cycles per minute.
2. 10,000 cycles on a plain resistance load at full rating of 15, 20 or 30 amperes, at 277 volts at 18-24 cycles per minute.
3. 10,000 cycles on an inductive load of either 15, 20 or 30 amperes at 277 volts, 80% power factor at 24 cycles per minute.
4. 10,000 cycles at 15, 20 or 30 amperes, 120 volts on a tungsten filament lamp load at 6-10 cycles per minute.
5. Temperature rise at test-rated load. In this test, temperature rise must not exceed 30 degrees Celsius.
6. A switch shall withstand, without breakdown, 1500 volts for 1 minute between live parts of opposite polarity and between live parts and dead metal parts, with the switch at the maximum operating temperature reached in intended use.

### Explanation of "Horsepower" Ratings

Manual motor controllers marked with Horsepower Ratings are suitable for controlling the Motor Loads of the HP ratings shown on the manual motor controllers for that operating voltage as well as for lower HP ratings.

To qualify for an HP rating, a manual motor controllers is tested at (6) six times the full load Motor Current corresponding to the HP rating marked on the switch. (For DC Motor Controllers, the test is made at 10 times the full load Motor Current corresponding to the DC HP rating marked on the switch). The test consists of 50 on-off operations at this load and the test is conducted on (3) three samples. For  $\frac{3}{4}$  HP 120 - 240 volts AC rating, (2) two sets of (3) three samples each are tested in addition to the regular overload, endurance, temp. rise and dielectric tests. The test circuit characteristics are:

	For $\frac{3}{4}$ HP 120V AC	For $\frac{3}{4}$ HP 240V AC
Closed Circuit Volts	120 volts AC	240 volts AC
Current	82.8 amps	41.4 amps
Power Factor	0.40-0.50	0.40-0.50

*Note: Current at 240V AC is  $\frac{1}{2}$  that at 120V AC*

All manual motor controllers must be in good operating condition after the tests have been completed. There must be no excessive arcing, welding or burning of the contacts nor arc-over to the ground (the manual motor controller frames are grounded during the stalled rotor test).



## Wiring Device Standards and Testing

### Wiring Device Standards

---

There are many different marketing terms in the electrical industry to describe the various electrical receptacles available from different manufacturers. Some of these terms include: Spec-Grade, Commercial, Heavy Duty, Industrial, Hard-Use, etc. There are no clear or universal definitions for these terms. There is no criteria established to differentiate one term from the next. Reliance solely upon these terms is not a reliable measure of performance or durability in a given application.

Underwriters Laboratories (UL) recognized a need to categorize receptacles based on application and expectations of performance. As a result, UL verifies performance to the following designations. Here are brief descriptions of each:



**General Use - UL 498** – All duplex receptacles are required to meet these general requirements. Devices bearing the UL mark for general use have been tested to insure they can safely provide power in typical everyday usage (vacuum, lamps, electronics, etc.).



Fed. Spec.

**Fed. Spec. - W-C-596** – The Federal Government wanted some way to determine that a receptacle performed better than average and would withstand the tougher demands of institutional use (post offices, military installations, prisons, etc.). Fed. Spec. listing identifies receptacles as having construction features, marking specifications and performance requirement (i.e., plug retention, increased cycle testing) beyond the requirements of the general use listing.



• Hospital Grade

**Hospital Grade** – In addition to compliance with general use requirements, Hospital Grade receptacles must meet performance criteria designed to test: ground reliability, assembly integrity, overall strength and reliability. Hospital Grade devices are marked with a green dot on their face.



Fed. Spec.

• Hospital Grade

**Hospital Grade Fed. Spec.** – Receptacles meeting this designation meet requirements and have completed test programs for both Fed. Spec. and Hospital Grade receptacles. All Hubbell Hospital Grade devices are UL listed to this designation.

These UL designations are a better determinant of performance than marketing descriptions, for performance and durability.





## Wiring Device Standards and Testing

### Testing for Hospital Grade and Fed. Spec. Listing of Hubbell Receptacles, Plugs and Connectors

---

All Hubbell Hospital Grade products are tested quarterly in our factories with Underwriters Laboratories.

#### Receptacles

---

**Fed. Spec. Test: Ground Pin Retention Test** - The grounding contact of the receptacle is conditioned by twenty insertions with a 0.204 inch oversized diameter pin. After conditioning, a 0.184 inch diameter pin is inserted in the grounding contact must be capable of supporting a weight of at least 4 ounces for one minute.

**Fed. Spec. Test: Power Blade Retention Test** - A test plug with a single oversized blade measuring 0.075 inch thick is inserted into each current carrying contact for twenty conditioning cycles. When the conditioning cycles are completed, each contact must be capable of supporting, for one minute, 1.5 pounds secured to a single 0.055 inch thick solid steel blade without holes.

**HG Test: Abrupt Removal of Plug Test** - A steel bodied test plug with blades made of brass is inserted into the receptacle. A 10 pound weight dropped from at least 24 inches, pulls the plug out of the receptacle abruptly. This test is done eight times with the receptacle rotated in different positions to create the greatest stress to the face and contacts. Then, with the receptacle facing down, the grounding contact must retain a 4 ounce grounding pin with a 0.184 inch diameter for one minute. After this test there shall be no breakage of the receptacle that interferes with the receptacle function or to the integrity of the enclosure.

**Fed. Spec. Test: Assembly Security Test** - A force of 100 pounds is applied through the slots of the receptacle into the base while the bridge is supported at its screw mounting positions. Each receptacle is then examined for damage.

#### Plugs and Connectors

---

**HG Test: Impact Test** - A plug or connector wired with the minimum size flexible cord is subjected to an impact from a 10 pound cylindrical weight having a flat face with a 2 inch diameter dropped from a height of 18 inches. After the test, there shall be no breakage or other damage that may effect the function of the device.

**HG Test: Mechanical Drop Test** - The cord connector is wired to #18 AWG flexible cord and suspended horizontally. It is released so it impacts a hardwood surface 45 inches below the point of suspension. This is repeated for 1,300 cycles. After the test, there shall be no breakage, deformation or other effect that may interfere with the function of the device.

**HG Test: 500 Pound Crush Test** - A wired plug or connector is placed between two hardwood slabs while subjected to a force which is progressively increased to 500 pounds. After the test, there shall be no breakage, deformation or other effect that may interfere with the function of the device.

**HG Test: Strain Relief Test** - While assembled to a plug or connector but not wired to the terminals; the cord must remain securely fastened after a straight pull of 30 pounds and a rotary motion within 3 inch circles with a 10 pound force applied for two consecutive hours. Displacement of conductors, insulation and outer jacket of the flexible cord shall not exceed 0.031 inch. There shall be no cuts, rips or tears in the insulation of the cord.



## RoHS, WR, TR and LED Power Descriptions



### RoHS - Restriction of Hazardous Substances

This EU Directive, 2002/95/EC, prohibits the use of mercury, cadmium, lead, chromium VI, PBB (polybrominated biphenyls) and PBDE (polybrominated diphenyl ethers) in certain electrical products. The regulatory maximums for these items are 0.01%, by weight, for cadmium and 0.1%, by weight, for the other five items in each "homogenous unit" contained within that product. There are certain exemptions available from the RoHS requirements.



### Weather Resistant Receptacles

Per National Electrical Code (NEC®) Section 406.9; all 125 and 250 volt, 15 and 20 amp non-locking receptacles for use in damp or wet locations shall be a listed weather resistant type. Listed devices are required to have a WR marking on the face visible when installed.



### Tamper-Resistant Receptacles

Per National Electrical Code (NEC®) Section 406.12 now addresses all 15 and 20 ampere, 125 and 250 volt nonlocking-type receptacles in the areas specified in 406.12(1) through (7) shall be listed tamper-resistant receptacles. New occupancies have been added to the receptacle tamper-resistant requirements: Dwelling units, guest rooms and guest suites of hotels and motels, child care facilities, preschools and elementary education facilities, business offices, corridors, waiting rooms and in clinics, medical and dental offices and outpatient facilities, places of waiting transportation, gymnasiums, skating rinks, auditoriums and dormitories.



### LED Power Indicators

Most popularly used to identify emergency circuits in hospitals, the LED power indicators are bright enough to be visible in low light as well as bright daylight conditions.

## Tamper-Resistant SG Series Duplex Receptacle, Hospital Grade. How the SG Tamper-Resistant Receptacle Works.

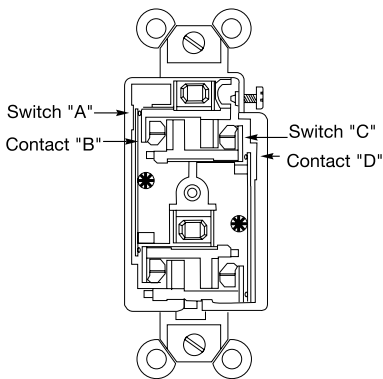

Figure 1

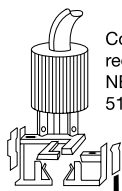

Figure 2

Complies with requirements of NEC Section 517-18(c).

As shown in Figure 1, Switch "A" energizes the left hand Contact "B" and Switch "C" energizes the right hand Contact "D". The same arrangement applies to the lower portion of the outlet.

If, for example, a metallic object is inserted into the left power Contact "B" only, the object is not energized because it requires the additional insertion of a similar object in the opposite Contact "D" to move the slider to close Switch "A".

Similarly, if an object is inserted into the right hand slot only, it cannot become energized unless and additional object is inserted in the opposite slot to close Switch "C".

In other words it requires the presence of an object in both right and left hand contacts to energize the device. This condition is in practice fulfilled only by the insertion of the proper electrical plug as shown in Figure 2.

Remember, this receptacle can be used with either a 2 or 3 wire plug. No other tamper-resistant receptacle on the market can provide you with greater reliability and durability than the Hubbell hospital grade tamper resistant receptacle.

Complies with requirements of NEC Section 517-18(c).



## NEMA and IEC Classifications

### Comparison Between NEMA Enclosure Type Numbers and IEC Enclosure Classification Designations

IEC Publication 60529 Classification of Degrees of Protection Provided by Enclosures provides a system for specifying the enclosures of electrical equipment on the basis of the degree of protection provided by the enclosure. IEC 60529 does not specify degrees of protection against mechanical damage of equipment, risk of explosions, or conditions such as moisture (produced for example by condensation), corrosive vapors, fungus, or vermin. NEMA Standards Publication 250 does test for environmental condition such as corrosion, rust, icing, oil, and coolants. For this reason, and because the tests and evaluations for other characteristics are not identical, the IEC Enclosure Classification Designations cannot be exactly equated with NEMA Enclosure Type Numbers. The IEC designation consists of the letters IP followed by two numerals. The first characteristic numeral indicates the degree of protection provided by the enclosure with respect to persons and solid foreign objects entering the enclosure. The second characteristic numeral indicates the degree of protection provided by the enclosure with respect to the harmful ingress of water.

The table below provides an equivalent conversion from NEMA Enclosure Type Numbers to IEC Enclosure Classification Designations. The NEMA Types meet or exceed the test requirements for the associated IEC Classifications; for this reason the table cannot be used to convert from IEC Classifications to NEMA Types.

### Conversion of NEMA Type Numbers to IEC Classification Designations

(Cannot be used to convert IEC classification designations to NEMA type numbers)

NEMA Enclosure Type Number	IEC Enclosure Classification Designation	Basic Description
1	IP10	General Purpose
2	IP11	Drip-proof- Indoor
3	IP54	Dusttight, Raintight and Sleet (Ice) Resistant- Outdoor
3R	IP14	Rainproof and Sleet (Ice) Resistant- Outdoor
3S	IP44, IP54	Dusttight, Raintight and Sleet (ice) Proof- Outdoor
4	IP56	Watertight and Dusttight- Indoor and Outdoor
4X	IP56	Watertight, Dusttight and Corrosion-Resistant - Indoor and Outdoor
5	IP52	Superseded by Type 12 for Control Apparatus
6	IP67	Submersible, Watertight, Dusttight and Sleet (Ice) Resistant- Indoor and Outdoor
12	IP52	Industrial Use, Dusttight and Driptight- Indoor
12K	IP52	Industrial Use, Dusttight and Driptight with Knockouts- Indoor
13	IP54	Oiltight and Dusttight- Indoor

### Elements of the IP Code and Their Meanings - In Accordance with Standard IEC 60529

IP Suitability Ratings are a system for classifying the degree of ingress protection provided by enclosures of electrical equipment. Generally, the higher the number, the greater the degree of protection; they apply ONLY to properly installed equipment.

### Example: IP67 = Ingress Protection/Dust-Tight/Temporary Immersion

#### Meaning for the Protection of Equipment

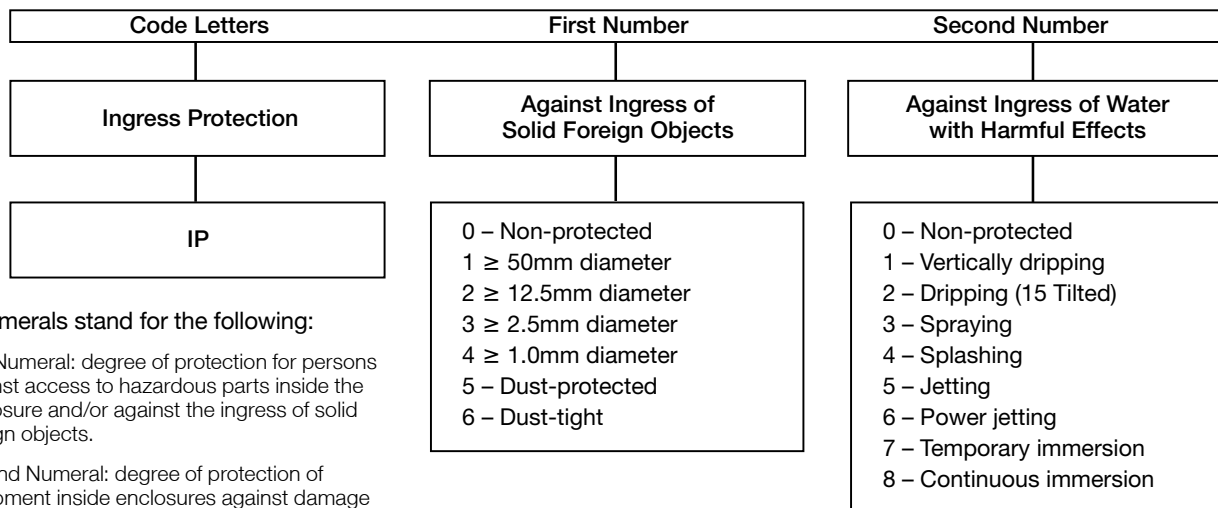

The numerals stand for the following:

1. First Numeral: degree of protection for persons against access to hazardous parts inside the enclosure and/or against the ingress of solid foreign objects.
2. Second Numeral: degree of protection of equipment inside enclosures against damage from the ingress of water.



## Enclosure Types for Self-Certified Non-Hazardous (Unclassified) Locations

	<b>NEMA Standards Publication No. 250 Enclosures for Electrical Equipment (1000 Volts maximum)</b>	<b>UL50E Standard for Enclosures for Electrical Equipment Environmental Considerations</b>	<b>CAN/CSA C22.2 No. 94.2 Special Purpose Enclosures</b>
<b>Designation</b>	<b>Intended Use and Description</b>	<b>Intended Use and Description</b>	<b>Intended Use and Description</b>
<b>Definition</b>	An enclosure is a surrounding case constructed to provide a degree of protection to personnel against incidental contact with the enclosed equipment and to provide a degree of protection to the enclosed equipment against specified environmental conditions.	Enclosure - A surrounding case constructed to provide a degree of protection against incidental contact with the enclosed equipment and to provide a degree of protection to the enclosed equipment against specified environmental conditions.	Enclosures...provide a degree of protection against accidental contact with the enclosed equipment, and to the enclosed equipment, against specified environmental conditions.
<b>Type 1</b>	Enclosures constructed for indoor use to provide a degree of protection to personnel against incidental contact with the enclosed equipment and to provide a degree of protection against falling dirt.	Indoor use primarily to provide a degree of protection against limited amounts of falling dirt.	No CSA equivalent.
<b>Type 2</b>	Enclosures constructed for indoor use to provide a degree of protection to personnel against incidental contact with the enclosed equipment, to provide a degree of protection against falling dirt, and to provide a degree of protection against dripping and light splashing of non-corrosive liquids.	Indoor use primarily to provide a degree of protection against limited amounts of falling water and dirt.	An enclosure for indoor use, constructed so as to provide a degree of protection against dripping and light splashing of non-corrosive liquids, and falling dirt.
<b>Type 3</b>	Enclosures constructed for either indoor or outdoor use to provide a degree of protection to personnel against incidental contact with the enclosed equipment; to provide a degree of protection against falling dirt, rain, sleet, snow, and windblown dust; and that will be undamaged by the external formation of ice on the enclosure.	Outdoor use primarily to provide a degree of protection against rain, sleet, windblown dust and damage from external ice formation.	An enclosure for either indoor or outdoor use, constructed so as to provide a degree of protection against rain, snow, and wind blown dust; undamaged by the external formation of ice on the enclosure.
<b>Type 3X</b>	Same as above and corrosion resistant.	Same as above and corrosion resistant.	Same as above and corrosion resistant.
<b>Type 3R</b>	Enclosures constructed for either indoor or outdoor use to provide a degree of protection to personnel against incidental contact with the enclosed equipment; to provide a degree of protection against falling dirt, rain, sleet, and snow; and that will be undamaged by the external formation of ice on the enclosure.	Outdoor use primarily to provide a degree of protection against rain, sleet, and damage from external ice formation.	An enclosure for either indoor or outdoor use, constructed so as to provide a degree of protection against rain and snow, undamaged by the external formation of ice on the enclosure.
<b>Type 3RX</b>	Same as above and corrosion resistant.	Same as above and corrosion resistant.	Same as above and corrosion resistant.
<b>Type 3S</b>	Enclosures constructed for either indoor or outdoor use to provide a degree of protection to personnel against incidental contact with the enclosed equipment; to provide a degree of protection against falling dirt, rain, sleet, snow, and windblown dust; and in which the external mechanism(s) remain operable when ice laden.	Outdoor use primarily to provide a degree of protection against rain, sleet, windblown dust, and to provide for operation of external mechanisms when ice laden.	An enclosure for either indoor or outdoor use, constructed so as to provide a degree of protection against rain, snow, and windblown dust, the external mechanism(s) remain operable while ice covered.
<b>Type 3SX</b>	Same as above and corrosion resistant.	Same as above and corrosion resistant.	Same as above and corrosion resistant.
<b>Type 4</b>	Enclosures constructed for either indoor or outdoor use to provide a degree of protection to personnel against incidental contact with the enclosed equipment; to provide a degree of protection against falling dirt, rain, sleet, snow, windblown dust, splashing water, and hose-directed water, and that will be undamaged by the external formation of ice on the enclosure.	Indoor or outdoor use primarily to provide a degree of protection against windblown dust and rain, splashing water, hose-directed water, and damage from external ice formation.	An enclosure for either indoor or outdoor use, constructed so as to provide a degree of protection against rain, snow, windblown dust, splashing and hose-directed water; undamaged by the external formation of ice on the enclosure.
<b>Type 4X</b>	Enclosures constructed for either indoor or outdoor use to provide a degree of protection to personnel against incidental contact with the enclosed equipment; to provide a degree of protection against falling dirt, rain, sleet, snow, windblown dust, splashing water, hose-directed water, and corrosion; and that will be undamaged by the external formation of ice on the enclosure.	Indoor or outdoor use primarily to provide a degree of protection against corrosion, windblown dust and rain, splashing water, hose-directed water and damage from external ice formation.	An enclosure for either indoor or outdoor use, constructed so as to provide a degree of protection against rain, snow, windblown dust, splashing and hose-directed water, undamaged by the external formation of ice on the enclosure; resists corrosion.



## Enclosure Types for Self-Certified Non-Hazardous (Unclassified) Locations

	<b>NEMA Standards Publication No. 250 Enclosures for Electrical Equipment (1000 Volts maximum)</b>	<b>UL50E Standard for Enclosures for Electrical Equipment Environmental Considerations</b>	<b>CAN/CSA C22.2 No. 94.2 Special Purpose Enclosures</b>
<b>Designation</b>	<b>Intended Use and Description</b>	<b>Intended Use and Description</b>	<b>Intended Use and Description</b>
<b>Type 5</b>	Enclosures constructed for indoor use to provide a degree of protection to personnel against incidental contact with the enclosed equipment; to provide a degree of protection against falling dirt; against settling airborne dust, lint, fibers, and flyings; and to provide a degree of protection against dripping and light splashing of liquids.	Indoor use primarily to provide a degree of protection against settling airborne dust, falling dirt, and dripping non-corrosive liquids.	An enclosure for indoor use, constructed so as to provide a degree of protection against dripping and light splashing of non-corrosive liquids and settling dust, lint, fibers, and flyings.
<b>Type 6</b>	Enclosures constructed for either indoor or outdoor use to provide a degree of protection to personnel against incidental contact with the enclosed equipment; to provide a degree of protection against falling dirt; against hose directed water and the entry of water during occasional temporary submersion at a limited depth; and that will be undamaged by the external formation of ice on the enclosure.	Indoor or outdoor use primarily to provide a degree of protection against hose-directed water, the entry of water during occasional temporary submersion at a limited depth, and damage from external ice formation.	An enclosure for either indoor or outdoor use, constructed so as to provide a degree of protection against the entry of water during occasional temporary submersion at a limited depth; undamaged by the external formation of ice on the enclosure.
<b>Type 6P</b>	Enclosures constructed for either indoor or outdoor use to provide a degree of protection to personnel against incidental contact with the enclosed equipment; to provide a degree of protection against falling dirt; against hose-directed water and the entry of water during prolonged submersion at a limited depth; and that will be undamaged by the external formation of ice on the enclosure.	Indoor or outdoor use primarily to provide a degree of protection against hose-directed water, the entry of water during prolonged submersion at a limited depth, and damage from external ice formation.	An enclosure for either indoor or outdoor use, constructed so as to provide a degree of protection against the entry of water during prolonged submersion at a limited depth; undamaged by the external formation of ice on the enclosure; resists extended corrosion.
<b>Type 12</b>	Enclosures constructed (without knockouts) for indoor use to provide a degree of protection to personnel against incidental contact with the enclosed equipment; to provide a degree of protection against falling dirt; against circulating dust, lint, fibers, and flyings; and against dripping and light splashing of liquids.	Indoor use primarily to provide a degree of protection against circulating dust, falling dirt, and dripping non-corrosive liquids.	An enclosure for indoor use, constructed so as to provide a degree of protection against circulating dust, lint fibers, and flyings; dripping and light splashing of non-corrosive liquids; and provided with knockouts.
<b>Type 12K</b>	Enclosures constructed (with knockouts) for indoor use to provide a degree of protection to personnel against incidental contact with the enclosed equipment; to provide a degree of protection against falling dirt; against circulating dust, lint, fibers, and flyings; and against dripping and light splashing of liquids.	Indoor use primarily to provide a degree of protection against circulating dust, falling dirt, and dripping non-corrosive liquids.	An enclosure for indoor use, constructed so as to provide a degree of protection against circulating dust, lint fibers, and flyings; dripping and light splashing of non-corrosive liquids; and provided with knockouts.
<b>Type 13</b>	Enclosures constructed for indoor use to provide a degree of protection to personnel against incidental contact with the enclosed equipment; to provide a degree of protection against falling dirt; against circulating dust, lint, fibers, and flyings; and against the spraying, splashing, and seepage of water, oil, and non-corrosive coolants.	Indoor use primarily to provide a degree of protection against dust, spraying of water, oil, and non-corrosive coolant.	An enclosure for indoor use, constructed so as to provide a degree of protection against circulating dust, lint, fibers, and flyings; seepage and spraying of non-corrosive liquids including oils and coolants.



## Circuit Wiring Diagrams

### Wiring Diagrams for NEMA Configurations

(Configurations shown are for female devices)

#### 125V – 2P, 2W

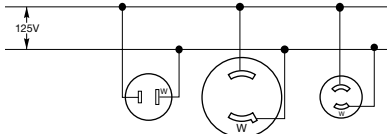

ANSI/NEMA WD-6 1-15R L1-15R ML1-R

#### 250V – 2P, 2W

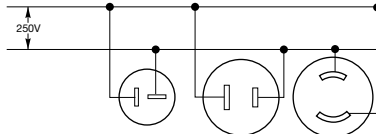

ANSI/NEMA WD-6 2-20R 2-30R L2-20R

#### 208V AC Line-to-Line\* – 2P, 2W

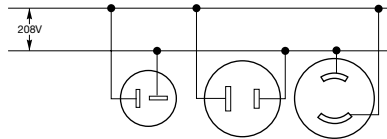

ANSI/NEMA WD-6 2-20R 2-30R L2-20R

#### 125V – 2P, 3W – Grounding

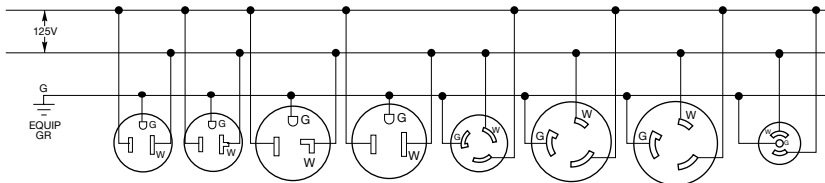

ANSI/NEMA WD-6 5-15R 5-20R 5-30R 5-50R L5-15R L5-20R L5-30R ML2-R

#### 250V – 2P, 3W – Grounding

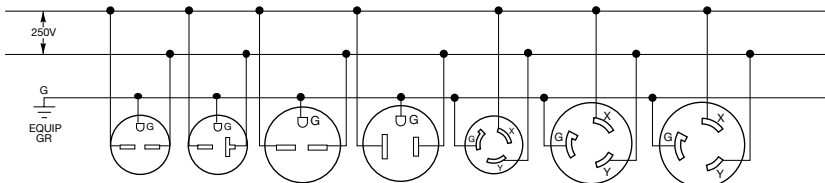

ANSI/NEMA WD-6 6-15R 6-20R 6-30R 6-50R L6-15R L6-20R L6-30R

#### 208V AC Line-to-Line\* – 2P, 3W – Grounding

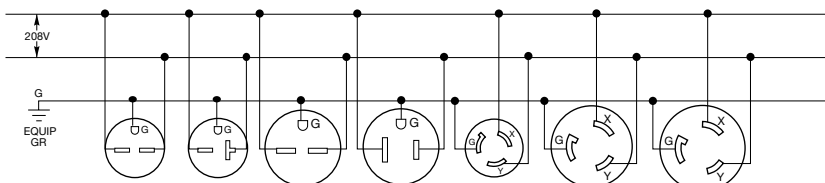

ANSI/NEMA WD-6 6-15R 6-20R 6-30R 6-50R L6-15R L6-20R L6-30R

Note: \*Does NOT encompass 208V AC Line-to-Neutral.

The above diagrams are intended to show device terminal identification only.





## Circuit Wiring Diagrams

### Wiring Diagrams for NEMA Configurations

(Configurations shown are for female devices)

#### 277V AC – 2P, 3W – Grounding

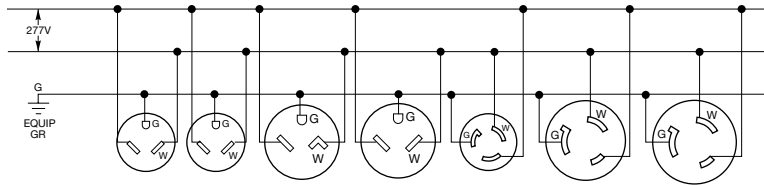

ANSI/NEMA WD-6 7-15R 7-20R 7-30R 7-50R L7-15R L7-20R L7-30R

#### 347V AC – 2P, 3W – Grounding

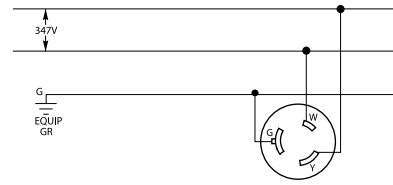

ANSI/NEMA WD-6 L24-20R

#### 480V AC – 2P, 3W – Grounding

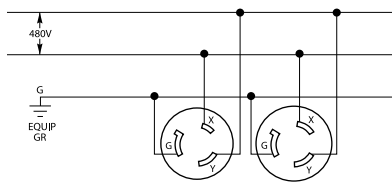

ANSI/NEMA WD-6 L8-20R L8-30R

#### 600V AC – 2P, 3W – Grounding

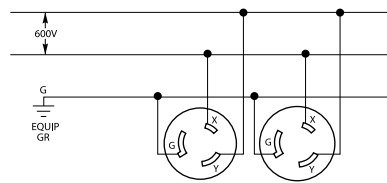

ANSI/NEMA WD-6 L9-20R L9-30R

#### 125/250V – 3P, 3W

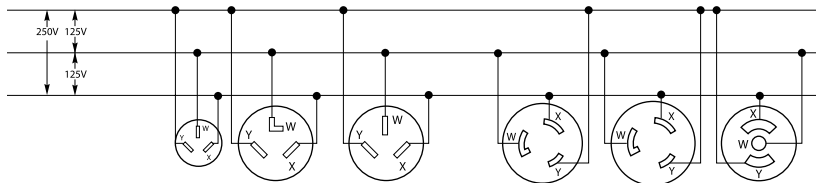

ANSI/NEMA WD-6 10-20R 10-30R 10-50R L10-20R L10-30R ML3-R

#### 1Ø 120/208YV AC – 3P, 3W

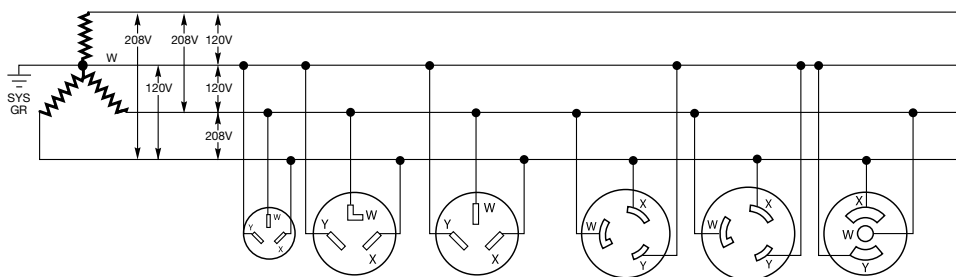

ANSI/NEMA WD-6 10-20R 10-30R 10-50R L10-20R L10-30R ML3-R

Note: The above diagrams are intended to show device terminal identification only.



## Circuit Wiring Diagrams

### Wiring Diagrams for NEMA Configurations

(Configurations shown are for female devices)

#### 3Ø 250V AC – 3P, 3W

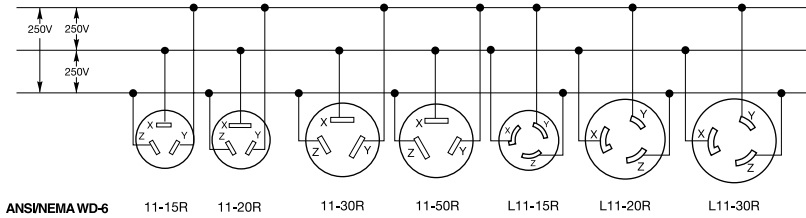

ANSI/NEMA WD-6 11-15R 11-20R 11-30R 11-50R L11-15R L11-20R L11-30R

#### 3Ø 480V AC – 3P, 3W

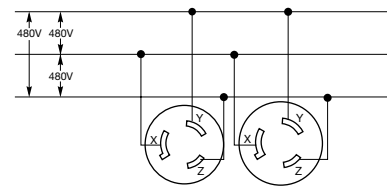

ANSI/NEMA WD-6 L12-20R L12-30R

#### 3Ø 600V AC – 3P, 3W

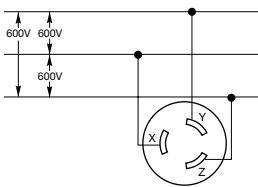

ANSI/NEMA WD-6 L13-30R

#### 125/250V – 3P, 4W

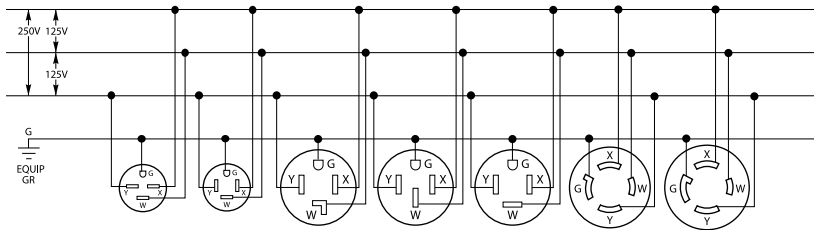

ANSI/NEMA WD-6 14-15R 14-20R 14-30R 14-50R 14-60R L14-20R L14-30R

#### 1Ø 120/208YV AC – 3P, 4W – Grounding

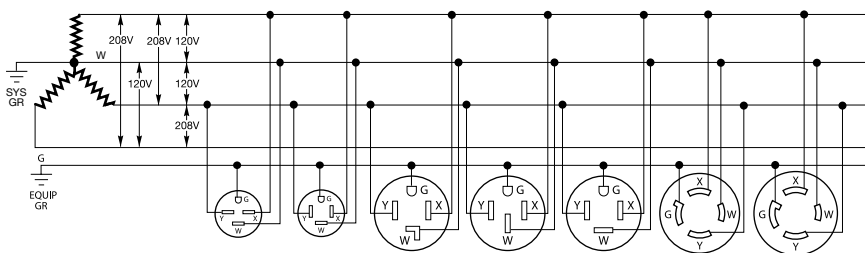

ANSI/NEMA WD-6 14-15R 14-20R 14-30R 14-50R 14-60R L14-20R L14-30R

Note: The above diagrams are intended to show device terminal identification only.



## Circuit Wiring Diagrams

### Wiring Diagrams for NEMA Configurations

(Configurations shown are for female devices)

#### 3Ø 250V – 3P, 4W – Grounding

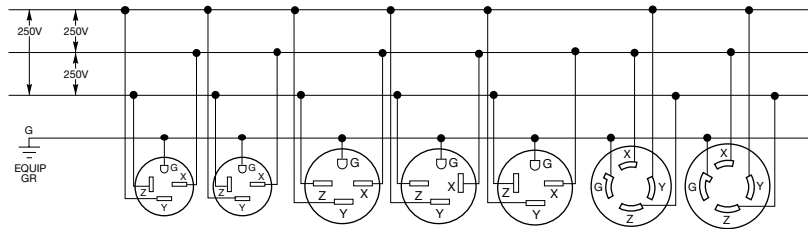

ANSI/NEMA WD-6 15-15R 15-20R 15-30R 15-50R 15-60R L15-20R L15-30R

#### 3ØY 277/480V AC – 4P, 4W

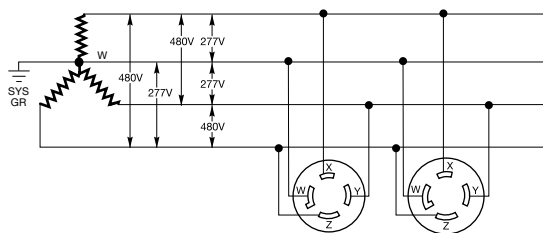

ANSI/NEMA WD-6 L19-20R L19-30R

#### 3ØY 347/600V AC – 4P, 4W

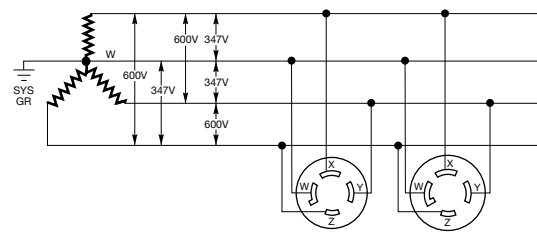

ANSI/NEMA WD-6 L20-20R L20-30R

#### 3Ø 480V AC – 3P, 4W – Grounding

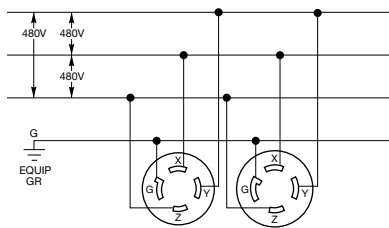

ANSI/NEMA WD-6 L16-20R L16-30R

#### 3Ø 600V AC – 3P, 4W – Grounding

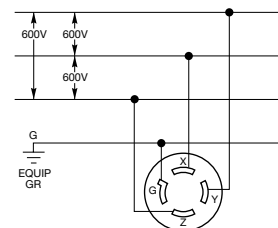

ANSI/NEMA WD-6 L17-30R

#### 3ØY 120/208V AC – 4P, 4W

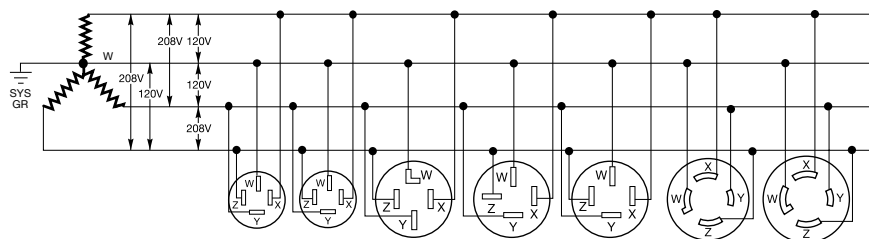

ANSI/NEMA WD-6 18-15R 18-20R 18-30R 18-50R 18-60R L18-20R L18-30R

Note: The above diagrams are intended to show device terminal identification only.



## Circuit Wiring Diagrams

### Wiring Diagrams for NEMA Configurations

(Configurations shown are for female devices)

#### 3ØY 120/208V AC – 4P, 5W – Grounding

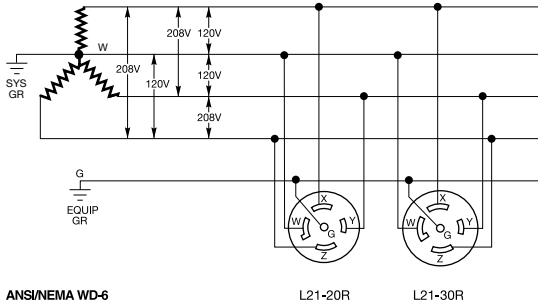

#### 3ØY 277/480V AC – 4P, 5W – Grounding

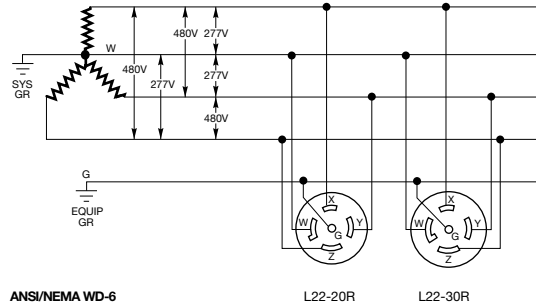

#### 3ØY 347/600V AC – 4P, 5W – Grounding

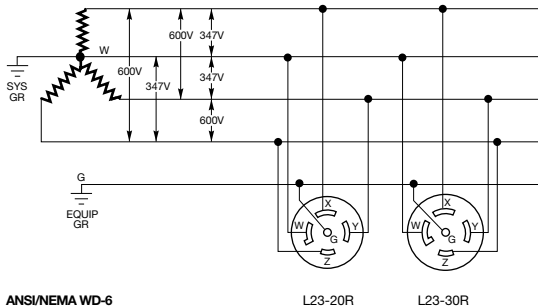

#### 3ØY 220/380V AC – 4P, 5W – Grounding

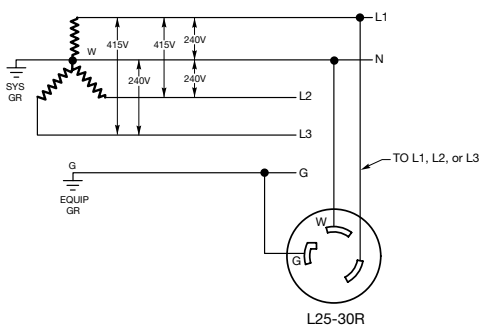

#### 3ØY 240/415V AC – 4P, 5W – Grounding

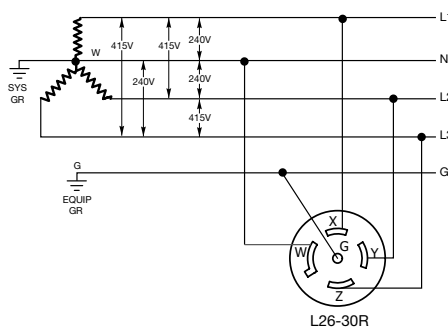

Note: The above diagrams are intended to show device terminal identification only.

# General Technical Data



## Horsepower Ratings and UL 508A Table SB4.1

### Horsepower Ratings for NEMA Configurations – Plugs and Receptacles Only

Straight Blade				Locking			
NEMA Configuration	AC HP Rating <sup>1</sup>	NEMA Configuration	AC HP Rating <sup>1</sup>	NEMA Configuration	AC HP Rating <sup>1</sup>	NEMA Configuration	AC HP Rating <sup>1</sup>
1-15	0.5	11-15	2	L1-15	0.5	L11-15	2
2-15	1.5*	11-20	3	L2-20	2*	L11-20	3
2-20	2*	11-30	3	L5-15	0.5	L11-30	3
2-30	2*	11-50	7.5	L5-20	1		
5-15	0.5	14-15	1.5 L-L*	L5-30	2	L12-20	5
5-20	1		0.5 L-N	L6-15	1.5*	L12-30	10
5-30	2	14-20	2 L-L*	L6-20	2*	L14-20	2 L-L*
5-50	2		1 L-N	L6-30	2*	L14-30	1 L-N
6-15	1.5*	14-30	2 L-L*	L7-15	2		2 L-L*
6-20	2*		2 L-N	L7-20	2		2 L-N
6-30	2*	14-50	3 L-L*	L7-30	3	L15-20	3
6-50	3*		2 L-N			L15-30	3
7-15	2	14-60	3 L-L*	L8-20	3	L16-20	5
7-20	2		2 L-N	L8-30	5	L16-30	10
7-30	3	15-15	2			L18-20	2
7-50	5	15-20	3			L18-30	3
		15-30	3	L10-20	2 L-L*		
10-20	2 L-L*	15-50	7.5		1 L-N	L19-20	5
	1 L-N	15-60	10			L19-30	10
10-30	2 L-L*	18-15	2	L10-30	2 L-L*	L21-20	2
	2 L-N	18-20	2		2 L-N	L21-30	3
10-50	3 L-L*	18-30	3			L22-20	5
	2 L-N	18-50	7.5			L22-30	10
		18-60	7.5			L25-30	2
						L26-30	7.5

Note: <sup>1</sup>The phase to phase horsepower ratings are noted "L-L". The phase to neutral ratings are identified "L-N".  
 \*Also suitable for 208V Line-to-Line, not 208V Line-to-Neutral.

### UL 231 Table 2.1, UL 508A Table SB4.1, UL 891 Table 16 - Assumed Maximum Short Circuit Current Rating for Unmarked Components When Used in UL 231 Power Outlets, UL 508A Industrial Control Panels, and UL 891 Switchboards

Component	Short Circuit Current Rating, kA
Bus bars	10
Circuit breaker (including GFCI type)	5
Current meters	a
Current shunt	10
Fuseholder	10
Industrial control equipment:	
a. Auxiliary devices (overload relay)	5
b. Switches (other than mercury tube type)	5
c. Mercury tube switches	
- Rated over 60 amperes or over 250 volts	5
- Rated 250 volts or less, 60 amperes or less, and over 2 kVA	3.5
- Rated 250 volts or less and 2 kVA or less	1
Motor controller, rated in horsepower (kW)	
a. 0 – 50 (0 – 37.3)	5c
b. 51 – 200 (38 – 149)	10c
c. 201 – 400 (150 – 298)	18c
d. 401 – 600 (299 – 447)	30c
e. 601 – 900 (448 – 671)	42c
f. 901 – 1500 (672 – 1193)	85c
Meter socket base	10
Miniature or miscellaneous fuse	10b
Receptacle (GFCI type)	2
Receptacle (other than GFCI type)	10
Supplementary protector	0.2
Switch unit	5
Terminal block or power distribution block	10

Note: a A short circuit current rating is not required when connected via a current transformer or current shunt.  
 A directly connected current meter shall have a marked short circuit current rating.  
 b The use of a miniature fuse is limited to 125-volt circuits.  
 c Standard fault current rating for motor controller rated within specified horsepower range.



## Isolated Ground Story

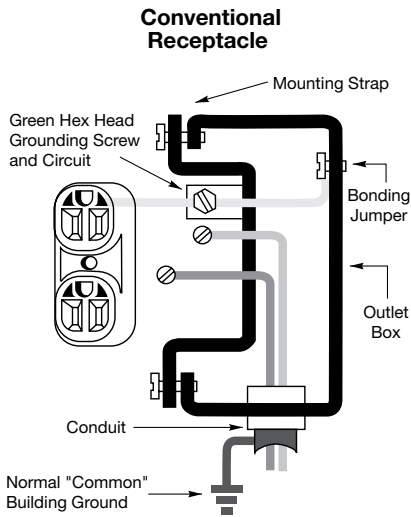

### Hubbell Isolated Ground Receptacles

Why do you need an isolated ground device?

When mounting a conventional receptacle in a steel box, the ground is commonly established through the existing electrical system. This is done by using either the grounding clip on the receptacle's mounting strap, or by running a ground wire (which is part of the "normal" existing system) to the green grounding screw.

In a conventional receptacle the grounding contacts are connected to the mounting strap and the green grounding screw. Thus, even when a separate green wire is brought to the receptacle, it is still tied into the normal ground. This occurs since the mounting strap is in contact with the box grounding system, therefore, a "pure" isolated path to the ground is not established.

### The Problem

The conventional grounding receptacle provides safety for personnel and equipment. However, the ground network also serves as a giant antenna and conductor of electrical noise. This electrical noise is electromagnetic interference and is caused by numerous transient ground currents. This can produce random transient electrical signals on the grounding system.

As a result, sensitive electronic equipment such as point of purchase terminals, accounting machines, computers and highly sensitive medical and communications equipment, can pick up these transient signals. This can interfere with the proper operation of the equipment.

### The Solution

The isolated ground receptacle is similar to a conventional receptacle except for one important change. Insulating barrier construction, first patented by Hubbell, isolates the ground contacts from the mounting strap. The green grounding screw is connected directly to the grounding contacts. The isolated equipment grounding circuit is completed by running an isolated ground wire to the green grounding screw. This ground wire passes through intermediate panel boards without being connected to their grounding terminal and terminates directly at an equipment grounding conductor terminal of the derived system or service, in accordance with NEC® requirements.

### The Result

This "isolated ground" can be kept relatively free of electrical noise. This is achieved since the grounding network has less branches, fewer sources of noise, and is connected to the ground at a single point.

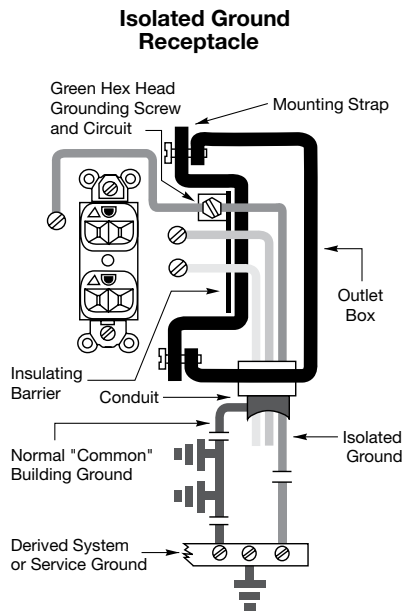





## Decimal Equivalents Table

### Decimal Equivalents Table

Inches	Inches	Millimeters	Inches	Inches	Millimeters
1/64	.015625	.3969	33/64	.515625	13.0969
1/32	.03125	.7938	17/32	.53125	13.4938
3/64	.046875	1.1906	35/64	.546875	13.8906
1/16	.0625	1.5875	9/16	.5625	14.2875
5/64	.078125	1.9844	37/64	.578125	14.6844
3/32	.09375	2.3813	19/32	.59375	15.0813
7/64	.109375	2.7781	39/64	.609375	15.4781
1/8	.1250	3.1750	5/8	.6250	15.8750
9/64	.140625	3.5719	41/64	.640625	16.2719
5/32	.15625	3.9688	21/32	.65625	16.6688
11/64	.171875	4.3656	43/64	.671875	17.0656
3/16	.1875	4.7625	11/16	.6875	17.4625
13/64	.203125	5.1594	45/64	.703125	17.8594
7/32	.21875	5.5563	23/32	.71875	18.2563
15/64	.234375	5.9531	47/64	.734375	18.6531
1/4	.2500	6.3500	3/4	.7500	19.0500
17/64	.265625	6.7469	49/64	.765625	19.4469
9/32	.28125	7.1438	25/32	.78125	19.8438
19/64	.296875	7.5406	51/64	.796875	20.2406
5/16	.3125	7.9375	13/16	.8125	20.6375
21/64	.328125	8.3344	53/64	.828125	21.0344
11/32	.34375	8.7313	27/32	.84375	21.4313
23/64	.359375	9.1281	55/64	.859375	21.8281
3/8	.3750	9.5250	7/8	.8750	22.2250
25/64	.390625	9.9219	57/64	.890625	22.6219
13/32	.40625	10.3188	29/32	.90625	23.0188
27/64	.421875	10.7156	59/64	.921875	23.4156
7/16	.4375	11.1125	15/16	.9375	23.8125
29/64	.453125	11.5094	61/64	.953125	24.2094
15/32	.46875	11.9063	31/32	.96875	24.6063
31/64	.484375	12.3031	63/64	.984375	25.0031
1/2	.5000	12.7000	1	1.0000	25.4000



## Electrical Symbols and Abbreviations

### Electrical Symbols and Abbreviations

#### General Outlets

##### Ceiling Wall

○ - ○	Lighting Outlet
Ⓟ - Ⓟ	Blanked outlet
Ⓣ	Deep cord
ⓔ - ⓔ	Electrical outlet: for use only when circle used alone might be confused with columns, plumbing symbols, etc.
ⓕ - ⓕ	Fan outlet
Ⓝ - Ⓝ	Junction box
Ⓛ - Ⓛ	Lamp holder
Ⓛ <sub>s</sub> - Ⓛ <sub>s</sub>	Lamp holder with pull switch
Ⓢ - Ⓢ	Pull switch
Ⓥ - Ⓥ	Outlet for vapor discharge lamp
Ⓧ - Ⓧ	Exit light outlet
Ⓒ - Ⓒ	Clock outlet (specify voltage)

#### Convenience Outlets

⊖	Duplex convenience outlet
⊖ <sub>3</sub>	Convenience outlet other than duplex 1-single, 3-triplex, etc.
⊖ <sub>wp</sub>	Weatherproof convenience outlet
⊖ <sub>4</sub>	Range outlet
⊖ <sub>1</sub>	Switch and convenience outlet
⊖ <sub>R</sub>	Radio and convenience outlet
⊖ <sub>sp</sub>	Special purpose outlet (Des. in Spec.)
⊖ <sub>f</sub>	Floor outlet

#### Switch Outlets

S	Single pole switch
S <sub>2</sub>	Double pole switch
S <sub>3</sub>	Three way switch
S <sub>4</sub>	Four way switch
S <sub>D</sub>	Automatic door switch
S <sub>E</sub>	Electroliner switch
S <sub>K</sub>	Key operated switch
S <sub>P</sub>	Switch and pilot lamp
S <sub>CB</sub>	Circuit breaker switch
S <sub>WCB</sub>	Weatherproof circuit breaker
S <sub>MC</sub>	Momentary contact switch
S <sub>RC</sub>	Remote control switch
S <sub>WP</sub>	Weatherproof switch
S <sub>F</sub>	Fused switch
S <sub>WF</sub>	Weatherproof fused switch

#### Special Outlets

Any standard symbol as given above with the addition of a lower case subscript letter may be used to designate some special variation of standard equipment of particular interest in a specific set of architectural plans.

○ <sub>a,b,c,etc</sub>	When used they must be listed in the Key of Symbols on each drawing and if necessary further described in the specifications.
⊖ <sub>a,b,c,etc</sub>	
⊖ <sub>a,b,c,etc</sub>	

#### Panels, Circuits and Miscellaneous

■	Lighting panel
▨	Power panel
—	Branch circuit; concealed in ceiling or wall
- - -	Branch circuit; concealed in floor
.....	Branch circuit; exposed
→	Home run to panel board. Indicated number of circuits by number of arrows.

Note: Any circuit without further designation indicates a two-wire circuit.  
 Note: For double or single systems eliminate one or two lines. This symbol is equally adaptable to auxiliary system layouts.

—	Feeders
Note: Use heavy lines and designate by number of corresponding to listing in feeder schedule.	

⊖	Underfloor duct and junction box. Triple system
Note: For double or single systems eliminate one or two lines. This symbol is equally adaptable to auxiliary system layouts.	

ⓐ	Generator
Ⓜ	Motor
Ⓢ	Instrument
Ⓣ	Power transformer (or draw to scale)
Ⓧ	Controller
Ⓢ	Isolating switch

#### Auxiliary Systems

■	Push Button	⊖	Buzzer
Ⓢ	Bell	◇	Annunciator
Ⓢ	Outside telephone		
Ⓢ	Interconnecting telephone		
Ⓢ	Telephone switchboard		
Ⓢ	Bell ringing transformer		
Ⓢ	Electric door opener		
Ⓢ <sub>F</sub>	Fire alarm bell	Ⓢ <sub>F</sub>	Fire alarm station
Ⓢ	City fire alarm station		
Ⓢ <sub>FA</sub>	Fire alarm central station		
Ⓢ <sub>FS</sub>	Automatic fire alarm device		
Ⓢ <sub>W</sub>	Watchman's station		
Ⓢ <sub>W</sub>	Watchman's central station		
Ⓢ	Horn		
Ⓢ <sub>N</sub>	Nurse's signal plug	Ⓢ <sub>M</sub>	Maid's signal plug
Ⓢ	Radio outlet		
Ⓢ <sub>SC</sub>	Signal central section		
Ⓢ	Interconnection box	Ⓢ	Battery
- - - - -	Auxiliary system circuits.		

Note: Any line without further designation indicates a 2-wire system. For a greater number of wires designate with numerals in manner similar to - - - 12-No. 18 W-3'4"C, or designate by number corresponding to listing in schedule.

Ⓢ <sub>a,b,c</sub>	Special auxiliary outlets
Subscript letters refer to notes on plans or detailed description in specifications.	

# General Technical Data



## Diameter Ranges of Jacketed Cord and Wire Charts

### Diameter Ranges of Jacketed Cord Chart - In Accordance with Standard UL62

Acceptable range in inches (mm) of the average overall diameter of round, jacketed heater cords and non-retractile vacuum cleaner and service cords.

Type of Cord	AWG Size	2 Conductor	3 Conductor	4 Conductor	5 Conductor
<b>SV, SVE, SVEO, SVOO</b>	18	.22"- .26" (5.6-6.6)	.23"- .27" (5.8-6.9)	—	—
<b>SVO, SVT, SVTOO, SVTO</b>	16	.25"- .28" (6.2-7.1)	.26"- .30" (6.6-7.5)	—	—
<b>SJ, SJE, SJOO, SJO, SJEO, SJEOSJT, SJTO, SJTOO, SJEW, SJOOW, SJOW, SJEOW, SJEOW, SJTW, SJTOW, SJTOOW</b>	18	.28"- .32" (7.1-8.1)	.30"- .34" (7.6-8.6)	.33"- .37" (8.4-9.4)	—
	16	.31"- .34" (7.9-8.6)	.33"- .36" (8.4-9.1)	.35"- .40" (8.9-10.2)	—
	14	.34"- .38" (8.6-9.7)	.36"- .40" (9.1-10.2)	.39"- .44" (9.9-11.2)	—
	12	.41"- .46" (10.4-11.7)	.43"- .48" (10.9-12.2)	.47"- .52" (11.9-13.2)	—
	10	.54"- .61" (13.7-15.5)	.57"- .64" (14.5-16.3)	.63"- .70" (16.0-17.8)	—
<b>S, SE, SOO, SEO, SEOO, ST STOO, STO, SEW, SOOW, SOW, SEOW, SEOW, STW, STOOW, STOW</b>	18	.34"- .39" (8.6-9.9)	.36"- .40" (9.1-10.2)	.39"- .43" (9.9-10.9)	.46"- .51" (11.7-13.0)
	16	.37"- .41" (9.4-10.4)	.39"- .43" (9.9-10.9)	.41"- .46" (10.4-11.7)	.49"- .55" (12.4-14.0)
	14	.50"- .55" (12.7-14.0)	.52"- .58" (13.2-14.7)	.56"- .62" (14.2-15.7)	.63"- .71" (16.0-18.0)
	12	.57"- .63" (14.5-16.0)	.59"- .66" (15.0-16.8)	.64"- .71" (16.3-18.0)	.70"- .77" (17.8-19.6)
	10	.62"- .69" (15.7-17.5)	.65"- .72" (16.5-18.3)	.70"- .78" (17.8-19.8)	.76"- .84" (19.3-21.3)
	8	.78"- .88" (19.8-22.4)	.83"- .93" (21.1-23.6)	.93"- 1.05" (23.6-26.7)	1.00"- 1.15" (25.4-29.2)
	6	.92"- 1.05" (23.4-26.7)	.97"- 1.10" (24.6-27.9)	1.05"- 1.20" (26.7-30.5)	1.18"- 1.33" (30.0-33.8)
	4	1.06"- 1.21" (26.9-30.7)	1.13"- 1.28" (28.7-32.5)	1.25"- 1.45" (31.8-36.8)	—
	2	1.21"- 1.40" (30.7-35.6)	1.30"- 1.50" (33.0-38.1)	1.45"- 1.65" (36.8-41.9)	—

### Nominal Diameters of Round Portable Power Cable - In Accordance with Standard CSA-C22.2 No. 96

Type of Cord	AWG Size	2 Conductor	3 Conductor	4 Conductor	5 Conductor
<b>W, G, G-GC, G-BGC, PPC</b>	6	0.945" (24.0)	0.984" (25.0)	1.102" (28.0)	1.220" (31.0)
	4	1.063" (27.0)	1.142" (29.0)	1.260" (32.0)	1.417" (36.0)
	3	1.181" (30.0)	1.220" (31.0)	1.339" (34.0)	1.496" (38.0)
	2	1.260" (32.0)	1.339" (34.0)	1.496" (38.0)	1.614" (41.0)
	1	1.339" (34.0)	1.496" (38.0)	1.654" (42.0)	1.890" (48.0)
	1/0	1.417" (36.0)	1.614" (41.0)	1.772" (45.0)	1.929" (49.0)
	2/0	1.535" (39.0)	1.732" (44.0)	1.929" (49.0)	2.047" (52.0)
	3/0	1.654" (42.0)	1.890" (48.0)	2.047" (52.0)	2.244" (57.0)
	4/0	1.772" (45.0)	2.008" (51.0)	2.244" (57.0)	2.441" (62.0)

### Wire Types Approximate Diameter in Inches (mm)\*

Size (AWG or kcmil)	THHN, THWN, THWN-2 Inches (mm)	TW, THHW, THW, THW-2 Inches (mm)	XHHW, ZW, XHHW-2, XHH Inches (mm)
12	0.130 (3.302)	0.152 (3.861)	0.152 (3.861)
10	0.164 (4.166)	0.176 (4.470)	0.176 (4.470)
8	0.216 (5.486)	0.236 (5.994)	0.236 (5.994)
6	0.254 (6.452)	0.304 (7.722)	0.274 (6.960)
4	0.324 (8.230)	0.352 (8.941)	0.322 (8.179)
3	0.352 (8.941)	0.380 (9.652)	0.350 (8.890)
2	0.384 (9.754)	0.412 (10.46)	0.382 (9.703)
1	0.446 (11.23)	0.492 (12.50)	0.442 (11.23)
1/0	0.486 (12.34)	0.532 (13.51)	0.482 (12.34)
2/0	0.532 (13.51)	0.578 (14.68)	0.528 (13.41)
3/0	0.584 (14.83)	0.630 (16.00)	0.580 (14.73)
4/0	0.642 (16.31)	0.688 (17.48)	0.638 (16.21)
250	0.711 (18.06)	0.765 (19.43)	0.705 (17.91)
300	0.766 (19.46)	0.820 (20.83)	0.760 (19.30)
350	0.817 (20.75)	0.871 (22.12)	0.811 (20.60)
400	0.864 (21.95)	0.918 (23.32)	0.858 (21.79)
500	0.949 (24.10)	1.003 (25.48)	0.943 (23.95)
600	1.051 (26.70)	1.113 (28.27)	1.053 (26.75)
700	1.122 (28.50)	1.184 (30.07)	1.124 (28.55)
750	1.156 (29.36)	1.218 (30.94)	1.158 (29.41)
800	1.188 (30.18)	1.250 (31.75)	1.190 (30.23)
900	1.252 (31.80)	1.314 (33.38)	1.254 (31.85)
1000	1.310 (33.27)	1.372 (34.85)	1.312 (33.32)

Note: \*Information Sourced from the National Electrical Code.



## IEC Pin and Sleeve Terminal Identification

### IEC Pin and Sleeve Terminal Identification – Rear View

Description	Rating		Terminal Marking Pattern*			
			Receptacle and Connector		Plug and Inlet	
	Domestic	International	Domestic	International	Domestic	International
3 Wire	125V AC 277V AC	100-130V				
3 Wire	250V AC 480V AC 600V AC	200-250V 380-415V AC				
4 Wire	125/250V AC 1ØY 120/208V	—				
4 Wire	(3Ø Δ) 250V AC 480V AC 600V AC	380-415V AC				
5 Wire	(3ØY) 120/208V AC 277/480V AC 347/600V AC	220/380V 50Hz 250/440V 60Hz 200/346V to 240/415V 50 and 60Hz				

Note: \*Location of grounding contact position will change as clock positions assigned to specific voltages change.  
 ★Pilot contacts supplied on 4 and 5 wire, 63 and 125 Amp international rated devices.



## Horsepower Ratings

### Horsepower Ratings for Hubbell IEC Pin and Sleeve Devices\*

#### Single Phase

Amps	Wire Count	Voltage	Clock	Catalog Number	New HP Rating
20	3	125V	4	HBL320x4W	1
20	3	250V	6	HBL320x6W	2
20	3	480V	7	HBL320x7W	5
20	4	125/250 (208L-L)	12	HBL420x12W	2
20	4	125/250 (250L-L)	12	HBL420x12W	2
20	4	125/250 (125L-N)	12	HBL420x12W	1
30	3	125V	4	HBL330x4W	2
30	3	250V	6	HBL330x6W	3
30	3	480V	7	HBL330x7W	7.5
30	3	550VDC	8	HBL330X8	N/A
30	4	125/250 (208L-L)	12	HBL430x12W	3
30	4	125/250 (250L-L)	12	HBL430x12W	3
30	4	125/250 (125L-N)	12	HBL430x12W	2
60	3	125V	4	HBL360x4W	2
60	3	250V	6	HBL360x6W	3
60	3	480V	7	HBL360x7W	7.5
60	3	250VDC	3	HBL360x3W	N/A
60	3	550VDC	8	HBL360x8W	N/A
60	4	125/250 (208L-L)	12	HBL460x12W	3
60	4	125/250 (250L-L)	12	HBL460x12W	3
60	4	125/250 (125L-N)	12	HBL460x12W	2
100	3	125V	4	HBL3100x4W	5
100	3	250V	6	HBL3100x6W	15
100	3	480V	7	HBL3100x7W	30
100	3	250VDC	3	HBL3100x3W	N/A
100	3	550VDC	8	HBL3100x8W	N/A
100	4	125/250 (208L-L)	12	HBL4100x12W	10
100	4	125/250 (250L-L)	12	HBL4100x12W	15
100	4	125/250 (125L-N)	12	HBL4100x12W	5

#### 3-Phase

Amps	Wire Count	Voltage	Clock	Catalog Number	Present HP Rating	New HP Rating
20	4	3Ø 250V	9	HBL420x9W	2	5
20	4	3Ø 480V	7	HBL420x7W	5	10
20	4	3Ø 600V	5	HBL420x5W	7.5	10
20	4	3Ø 380-415V	6	HBL420x6W	-	7.5
20	5	3ØY 120/208V	9	HBL520x9W	0.5	3
20	5	3ØY 277/480V	7	HBL520x7W	5	10
20	5	3ØY 347/600V	5	HBL520x5W	7.5	10
20	5	3Ø 240/415V	6	HBL520x6W	-	5
30	4	3Ø 250V	9	HBL430x9W	3	7.5
30	4	3Ø 480V	7	HBL430x7W	7.5	15
30	4	3Ø 600V	5	HBL430x5W	10	20
30	5	3ØY 120/208V	9	HBL530x9W	2	5
30	5	3ØY 277/480V	7	HBL530x7W	7.5	15
30	5	3ØY 347/600V	5	HBL530x5W	10	20
30	4	3Ø 380/415V	6	HBL430x6W	-	10
30	5	3Ø 200/346-240/415	6	HBL530x6W	-	10
60	4	3Ø 250V	9	HBL460x9W	5	7.5
60	4	3Ø 480V	7	HBL460x7W	10	20
60	4	3Ø 600V	5	HBL460x5W	15	25
60	4	3Ø 380-415VAC	6	HBL460x6W	-	10
60	5	3ØY 120/208V	9	HBL560x9W	3	7.5
60	5	3ØY 277/480V	7	HBL560x7W	10	20
60	5	3ØY 347/600V	5	HBL560x5W	15	25
60	5	3Ø 200/346-240/415	6	HBL560x6W	-	10
100	4	3Ø 250V	9	HBL4100x9W	10	15
100	4	3Ø 480V	7	HBL4100x7W	30	40
100	4	3Ø 600V	5	HBL4100x5W	30	50
100	4	3Ø 380-415V	6	HBL4100x6W	-	30
100	5	3ØY 200/346-240/415V	6	HBL5100x6W	-	30
100	5	400VDC	8	HBL5100x8W	-	N/A
100	5	3ØY 120/208V	9	HBL5100x9W	10	15
100	5	3ØY 277/480V	7	HBL5100x7W	30	40
100	5	3ØY 347/600V	5	HBL5100x5W	30	50

Note: \*Horsepower Ratings are NOT standardized amongst different Pin and Sleeve manufacturers.



## Network Cabling Requirements

### Supported Media - International

Designation	ANSI/TIA-568-C	ISO/IEC 11801 Amend 2: 2010	CENELEC EN-50173-1: 2002
Category 3 (16 MHz)	Supported	Supported: Class C	Supported: Class C
Category 5e (100 MHz)	Supported	Supported: Class D	Supported: Class D
Category 6 (250 MHz)	Supported	Supported: Class E	Supported: Class E
Category 6A (500 MHz)	Supported	Supported: Class EA	Supported: Class EA
Category 7 (600 MHz)	Not Recognized	Supported: Class F	Supported: Class F
Category 7A (1,000 MHz)	Not Recognized	Supported: Class FA*	Supported: Class FA*
Category 8 (2,000 MHz)	Not Recognized	Supported: Class FA*	Supported: Class FA*
50/125 - 62.5/125 Multimode	Supported	Supported	Supported
Singlemode Fiber	Supported	Supported	Supported
Singlemode Fiber to the Work Area	Not Supported	Supported	Supported
Work Area Outlet Configuration	4 Pairs T568A or B	4 Pairs T568A Only	4 Pairs T568A Only
Stranded Patch Cord Attenuation	120% of Horiz. Cable	150% of Horiz. Cable	150% of Horiz. Cable

Note: \*Category 8 proposed in TIA 568-C.2-1 for 40 GBASE-T. ISO/IEC and cenelec to be determined. ISO/IEC and cenelec considering expanding Class FA frequency in addition to a considering new Class.

- Strip back only as much cable jacket as is required for termination and maintain pair twists as close as possible to the point of mechanical termination
- At a minimum, never allow untwisting of pairs as specified:  
Category 5e and 6/6A: 0.5 inch max.

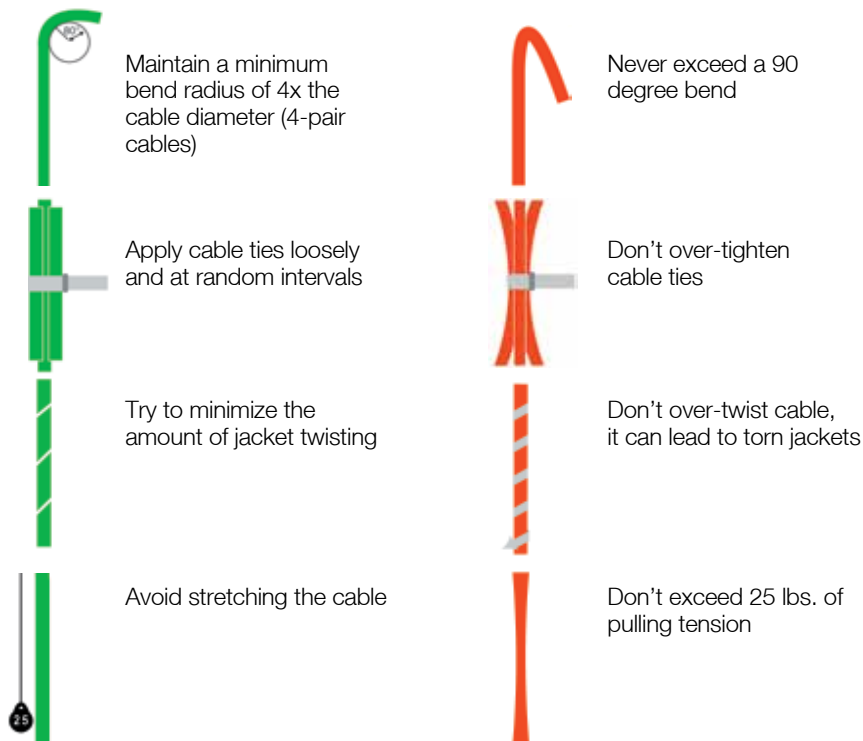

Use appropriate methods for dressing and securing cables:

- Cable ties
- Cable support bar
- Wire management panels
- Releasable straps

Don't use a staple gun to position cable