

# In-Floor Wire Management System Products

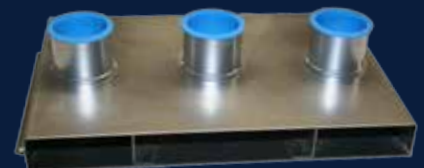

Conventional Underfloor Duct  
Flush Activation Underfloor Duct  
Casino/Heavy Duty Underfloor Duct

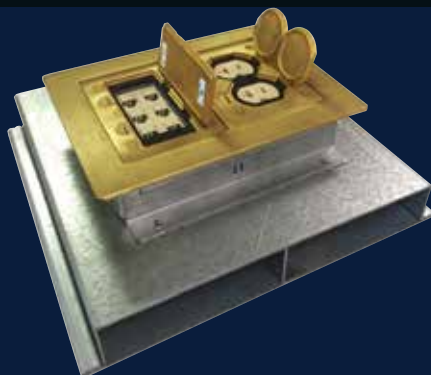

# Hubbell Underfloor Duct Series

## Multi-Compartment Underfloor Duct Saves Time and Money in Your In-Slab Wire Management System

Open Offices



Casinos



Retail



Fitness



Retrofit



The Hubbell Underfloor Duct system is an in-slab wire management product for delivering power, voice and data services for applications that include retail facilities, open office workstations, fitness centers, casinos, medical facilities and libraries. This system is uniquely designed with multiple compartments, allowing unlimited design options and cost savings in labor and materials from other single-compartment systems. Matched with our strong national distribution and complete technical/application support, the Hubbell Underfloor Duct System is the perfect solution for your underfloor wire management needs.

### Key Features and Benefits

- Eight duct profiles available to accommodate numerous in-slab wire management for power and communications.
- One-piece design multi-compartment duct, drastically reducing installation and material costs.
- Standard insert heights ranging from 1 to 3 inches (other heights available).
- Inclusive tile trim in square-top junction boxes, providing the installer the on-site option of using the trim or leaving it recessed.
- Combination duct coupler/support, reducing material and labor costs using the same part to join raceway sections together and to support/level the duct.
- Activation inserts are pre-assembled to the duct, or the inserts can be purchased separately for field installation only where you need them.
- Heavy duty junction boxes are available for areas requiring high-concentrated floor loads.
- Meets or exceeds UL 884 specifications, assuring a fully UL Listed system from one manufacturer.

### Flush Insert Duct Benefits

- Provides an aesthetic wire management solution for delivering power and communications services.
- Unique multi-gang flush inserts with removable voltage dividers provide the flexibility of installing multiple gangs of the same service at each insert location.
- Individual gangs can be activated as needed - keeps costs down.
- Activation trims accept standard Hubbell floor box covers for power and data, available in aluminum and brass.

### Ordering Information Note:

Floor Duct part numbers are for reference only. All Floor Duct orders are lot billed with a generic FD prefix project specific part numbers. Please contact your local Hubbell Territory Manager for all Hubbell Duct quotations.



## Conventional, Flush and Blank Underfloor Duct Profiles

### Ordering Information Note:

Floor Duct part numbers are for reference only. All Floor Duct orders are lot billed with a generic FD prefix project specific part numbers. Please contact your local Hubbell Territory Manager for all Hubbell Duct quotations.

- All duct comes in standard 10 ft. lengths
- 14 gauge, G90 galvanized steel
- 2 Inch IPS (Iron Pipe Size) round inserts are die-cast zinc
- Rectangular inserts are 14 gauge, G90 galvanized steel

### Catalog Number System

SP202F - 2 - 12		
	Profile      Insert Height      Insert Spacing	
Round Insert Duct and Blank Duct	201      B = Blank	12 = 12"
	201W    1 = 1" (201 only)	24 = 24"
	202      15 = 1 ½"	(consult factory for special preset spacing)
	SP202    2 = 2"	
	202W    25 = 1 ½"	n/a for Blank Duct
	203      3 = 3**	
Flush Insert Duct	201F    1 = 1" (201F only)	12 = 12"
	201WF    15 = 1 ½***	24 = 24"
	202F      2 = 2"	(consult factory for special preset spacing)
	202WF    25 = 2 ½"	
	203F      3 = 3**	



Note: \* consult factory for heights greater than 3"  
\*\* 1 ½" min. required for duplex receptacles

### Dimensions

#### 201 & 201F

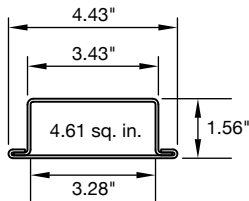

#### 201W & 201WF

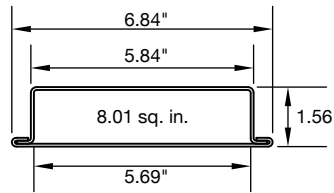

#### 202 & 202F

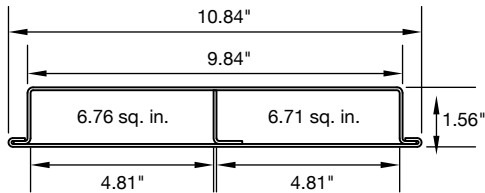

#### 203

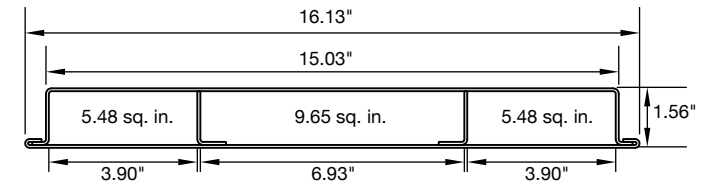

#### SP202 & SP202F

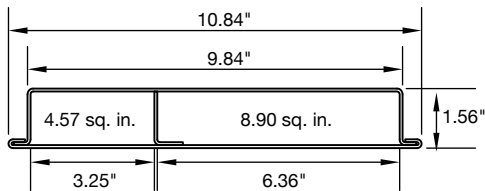

#### 203F

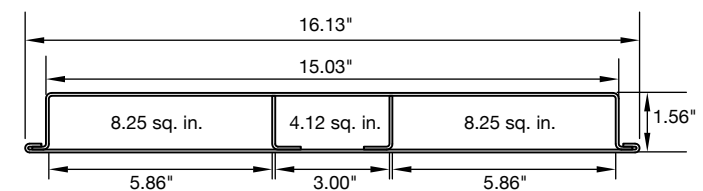

#### 202W & 202WF

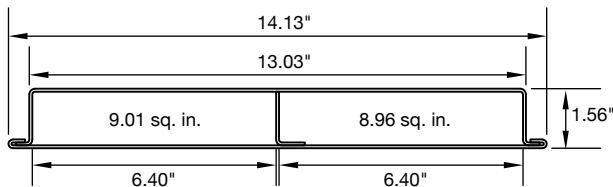

#### 204

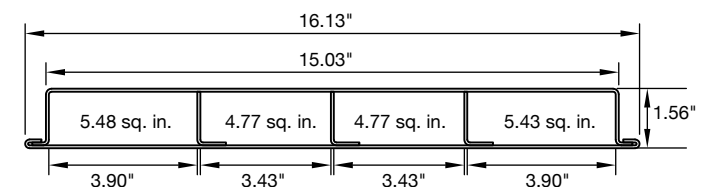

# Hubbell Underfloor Duct Series

## Technical Information and Wire Fill Capacity Chart



### Ordering Information Note:

Floor Duct part numbers are for reference only. All Floor Duct orders are lot billed with a generic FD prefix project specific part numbers. Please contact your local Hubbell Territory Manager for all Hubbell Duct quotations.

Duct Profile				201	201W	202		SP202		202W		203			203F			204				
Channel Cross Sectional Area (sq. in.)				201F	201WF	202F	202F	SP202F	SP202F	202WF	202WF											
Channel				A	A	A	B	A	B	A	B	A	B	C	A	B	C	A	B	C	D	
Cable Type	Size	Approx. Diameter (in.)	Approx. Area (sq in.)																			
Power (THHN)	14 AWG	0.111	0.0097	190	331	279	277	188	367	372	370	226	398	226	341	170	341	226	197	197	224	
	12 AWG	0.130	0.0133	138	241	203	202	137	268	271	270	165	290	165	248	124	248	165	143	143	163	
	10 AWG	0.164	0.0211	87	151	128	127	86	168	170	169	103	182	103	156	78	156	103	90	90	102	
	8 AWG	0.216	0.0366	50	87	73	73	49	97	98	97	59	105	59	90	44	90	59	52	52	59	
Coax Cables	RG-6/U	0.270	0.0573	32	55	47	46	31	62	62	62	38	67	38	57	28	57	38	33	33	37	
	RG-6/UQ	0.298	0.0697	26	45	38	38	26	51	51	51	31	55	31	47	23	47	31	27	27	31	
LAN Cables	Cat 5e	0.210	0.0346	53	92	78	77	52	102	104	103	63	111	63	95	47	95	63	55	55	62	
	Cat 6	0.250	0.0491	37	65	55	54	37	72	73	73	44	78	44	67	33	67	44	38	38	44	
	Cat 6A	0.350	0.0962	19	33	28	27	18	37	37	37	22	40	22	34	17	34	22	19	19	22	
Fiber Optic Distribution Cables	2-6 Strand	0.190	0.0284	65	113	95	94	64	125	127	126	77	136	77	116	58	116	77	67	67	76	
	8-12 Strand	0.230	0.0415	44	77	65	64	43	85	86	86	52	92	52	79	39	79	52	45	45	52	
	16-24 Strand	0.350	0.0962	19	33	28	27	18	37	37	37	22	40	22	34	17	34	22	19	19	22	

Note: Cable quantities shown in this chart are based on a 40% wire fill capacity. Sizes of COAX, LAN and Fiber Optic cables are provided for example only. Consult cable manufacturer's specification for exact cable sizes.

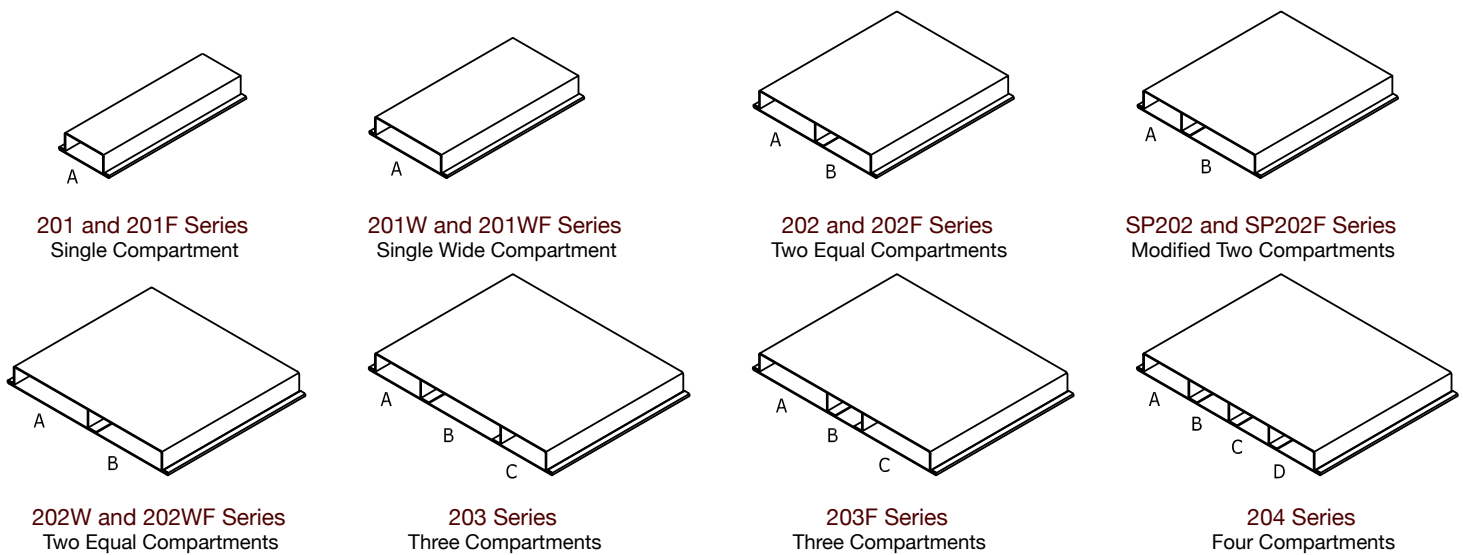

### Applicable Codes & Standards

- TIA/EIA 569-C "Commercial Building Standard for Telecommunications Pathways and Spaces"
- NEC Article 390 "Underfloor Raceways"
- Ampacity derating rules of NEC Article 310.15 (B)(3) applies to conductors installed in Underfloor Raceways and Trench Duct
- UL Standard UL 884 "Underfloor Raceways and Fittings"
- UL Listed E75939 (Underfloor Raceway) & E304554 (Underfloor raceway Fittings)



## Underfloor Duct Raceway Fittings



### Ordering Information Note:

Floor Duct part numbers are for reference only. All Floor Duct orders are lot billed with a generic FD prefix project specific part numbers. Please contact your local Hubbell Territory Manager for all Hubbell Duct quotations.

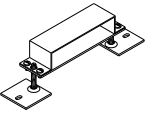
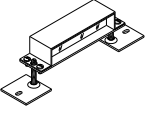
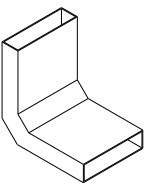
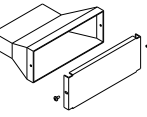
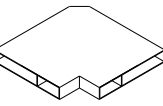
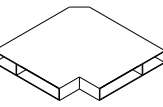
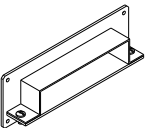
			Flush Insert Duct					Conventional Duct								
			201F	201WF	202F	SP202F	202WF	203F	201	201W	202	SP202	202W	203	204	
Coupler Support		Couples duct sections together and supports the duct. To be used every 5 feet of duct run.	201-DCS	•						•						
			201W-DCS		•						•					
			202-DCS			•	•					•	•			
			202W-DCS					•					•			
			203-DCS						•					•	•	
End Cap Support		Supports and closes unused duct ends.	201-ECS	•						•						
			201W-ECS		•						•					
			202-ECS			•	•					•	•			
			202W-ECS					•					•			
			203-ECS						•					•	•	
Vertical Riser		Transitions from duct embedded in concrete floor to vertical duct or may be used for direct connection to a Universal Conduit Adapter (UCA). Coupler / Supports (DCS) are required to attach to duct and UCA.	201-VEL	•						•						
			201W-VEL		•						•					
			202-VEL			•						•				
			SP202-VEL				•						•			
			202W-VEL					•					•			
			203-VEL						•					•		
			203F-VEL							•					•	
204-VEL													•			
Universal Conduit Adapter		Transitions from duct to conduit. A blank 14 gauge steel plate is provided for field punched conduit openings. For use with up to 2 1/2" trade size conduits. Consult factory for larger conduit accommodations. (may also be inserted directly into Junction Boxes)	201-UCA	•						•						
			201W-UCA		•						•					
			202-UCA			•						•				
			SP202-UCA				•						•			
			202W-UCA					•					•			
			203-UCA						•					•		
			203F-UCA							•					•	
204-UCA													•			
Horizontal 90 Degree Elbow	 SP202-HB90-NIR  SP202-HB90-NOR	Provides a horizontal 90 degree turn in floor duct. No hand access provided. Consult factory for other angles.  SP202-HB90's must be specified either with the Narrow Compartment located at the inside radius (-NIR) or at the outside radius (-NOR) as shown in illustration.	201-HB90	•						•						
			201W-HB90		•							•				
			202-HB90			•							•			
			SP202-HB90-NIR				•						•			
			SP202-HB90-NOR					•					•			
			202W-HB90					•					•			
			203-HB90						•					•		
			203F-HB90							•					•	
204-HB90													•			
Cabinet Connector		Provides a means for connecting duct to an electrical cabinet	201-DCC	•						•						
			201W-DCC		•						•					
			202-DCC			•	•					•	•			
			202W-DCC					•					•			
			203-DCC						•					•	•	

# Hubbell Underfloor Duct Series

## Underfloor Duct Raceway Junction Boxes and Accessories



### Ordering Information Note:

Floor Duct part numbers are for reference only. All Floor Duct orders are lot billed with a generic FD prefix project specific part numbers. Please contact your local Hubbell Territory Manager for all Hubbell Duct quotations.

- x = Preset Insert Height**  
**1 = 1"** (201 & 201F only)  
**15 = 1 1/2"** (min. required for duplex recept.)  
**2 = 2"**  
**25 = 2 1/2"**  
**3 = 3"** (consult factory for heights greater than 3")

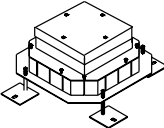
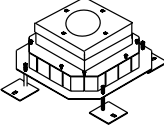
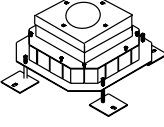
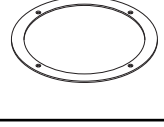
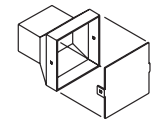
Junction Box Square Access 	For providing square opening access at intersections of Feeder Duct and Distribution Duct	201-JB-x
		201W-JB-x
		202-JB-x
		SP202-JB-x
		202W-JB-x
		203-JB-x
		203F-JB-x
Junction Box Round Access 	For providing round opening access at intersections of Feeder Duct and Distribution Duct. Provided with Brass or Stainless Steel Carpet Ring  *Available in Stainless Steel. To order replace B with SS	201-JB-x-RCB*
		201W-JB-x-RCB*
		202-JB-x-RCB*
		SP202-JB-x-RCB*
		202W-JB-x-RCB*
		203-JB-x-RCB*
		203F-JB-x-RCB*
Junction Box Heavy Duty Round Access 	Same as above except cover plates are 3/8" thick and after-pour height adjustable. Carpet Rings and Closure Caps must be ordered separately.  Duct Entrance Cap- <b>HDJBDC</b> Corner Cap- <b>HDJBCC</b>	202-JB-x-HD-ADJ
		SP202-JB-x-HD-ADJ
		202W-JB-x-HD-ADJ
Carpet Ring for Heavy Duty Junction Boxes 	1/8" thick Carpet Trim for Heavy Duty Junction Boxes. *Available in Stainless Steel. To order replace BRASS with SS	RD-BRASS*-202-ADJ
		RD-BRASS*-SP202-ADJ
		RD-BRASS*-202W-ADJ
Junction Box Corner Conduit Adapter 	Provides attachment point for conduit to each corner of all junction boxes. JB-CCA is provided with 14 gauge steel plate for field punched conduit opening. All other adapters are factory punched.	JB-CCA
		JB-CCA-1/2
		JB-CCA-3/4
		JB-CCA-1
		JB-CCA-1-1/2
		JB-CCA-2

Flush Insert Duct						Conventional Duct						
201F	201WF	202F	SP202F	202WF	203F	201	201W	202	SP202	202W	203	204
●						●						
	●						●					
		●						●				
			●						●			
				●						●		
					●						●	
												●

### Hubbell Trench Duct is commonly used as a feeder system for Underfloor Duct Raceway systems.



Factory assembled Trench/Underfloor duct intersect units allow unrestricted capacity by the elimination of tunnels. Side mounted Underfloor duct is available for shallow concrete pours. Consult factory for details.

- High capacity design supports large cables for single and multiple service requirements.
- Open top design allows cables to be easily laid in duct.
- Cover plates are removable and adjust horizontally to any point along the duct.
- Custom lengths of trench and fittings are available.
- Multiple compartments allow complete separation of services.
- Innovative duct support assembly allows for pre-pour leveling and acts as a splice for duct sections.

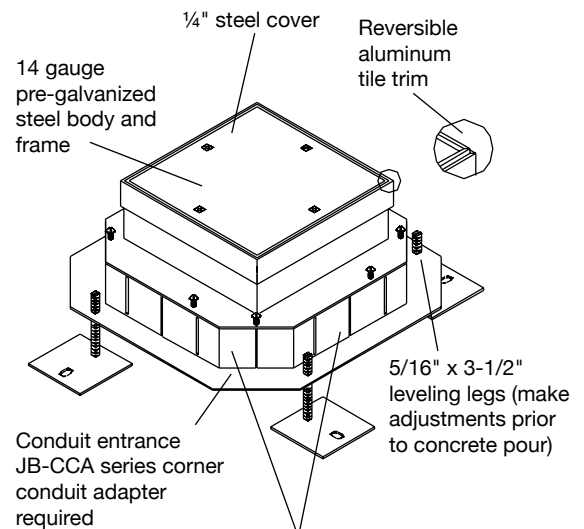

Removable pry-out sections for corner conduit adapters and duct entrances. Additional blanking plates not required for unused junction box entrances. Blanking plates must be ordered separately for heavy duty junction boxes.





## Underfloor Duct Junction Box Dimensions

### Ordering Information Note:

Floor Duct part numbers are for reference only. All Floor Duct orders are lot billed with a generic FD prefix project specific part numbers. Please contact your local Hubbell Territory Manager for all Hubbell Duct quotations.

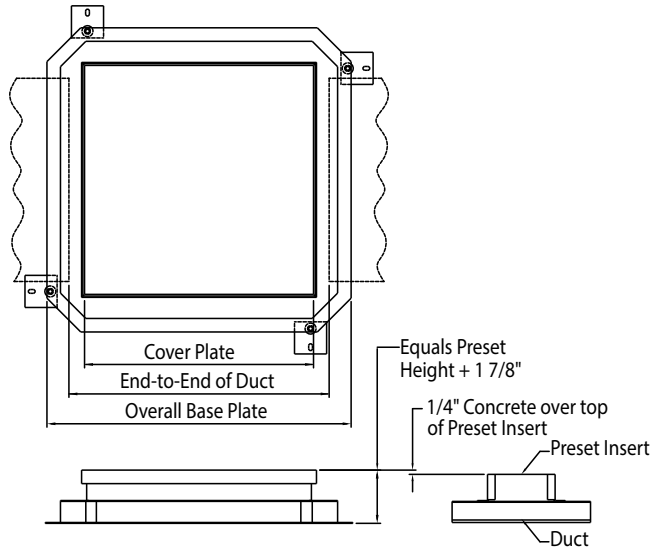

Junction Box Catalog Number	Cover Plate	End-To-End Of Duct	Overall Base Plate
201-JB-x 201-JB-x-RCx	6 5/16"	8"	10 1/2"
201W-JB-x 201W-JB-x-RCx	12 9/16"	14 1/2"	17 13/16"
202-JB-x 202-JB-x-RCx			
SP202-JB-x SP202-JB-x-RCx	17"	19 5/8"	22 11/16"
202W-JB-x 202W-JB-x-RCx			
203-JB-x 203-JB-x-RCx			
203F-JB-x 203F-JB-x-RCx	17"	19 5/8"	22 11/16"
204-JB-x 204-JB-x-RCx			
202-JB-x-HD-ADJ SP202-JB-x-HD-ADJ 202W-JB-x-HD-ADJ	Consult Factory For Dimensions		

## Underfloor Duct Raceway Aftersets and Marker Caps

Flush Insert Duct		Description	Catalog Number			
Afterset Insert		Provides means to add activation inserts in the field where needed prior to concrete pour. 14 gauge steel.	1-Gang	1 1/2" Insert Height 2" Insert Height 3" Insert Height	DAIFA-1G-15 DAIFA-1G-2 DAIFA-1G-3	
			2-Gang	1 1/2" Insert Height 2" Insert Height 3" Insert Height	DAIFA-2G-15 DAIFA-2G-2 DAIFA-2G-3	
				3-Gang	1 1/2" Insert Height 2" Insert Height 3" Insert Height	DAIFA-3G-15 DAIFA-3G-2 DAIFA-3G-3
					Marker Cap	Marker caps are used in place of standard insert caps in (a) each insert adjacent to junction box, (b) inserts on each side of a permanent wall, and (c) the last insert in each run of duct.
			Compartment Cover	Used for abandoning preset opening (one per gang). 18 gauge steel,	Blank Cover	FA-MC

Round Insert Duct		Description	Catalog Number				
Afterset Insert		Provides means to add activation inserts in the field where needed prior to or after concrete pour. Zinc die cast.	1" Insert Height	DAI-1			
			2" Insert Height	DAI-2			
			3" Insert Height	DAI-3			
			4" Insert Height	DAI-4			
Marker Cap		Marker caps are used in place of standard insert caps in (a) each insert adjacent to junction box, (b) inserts on each side of a permanent wall, and (c) the last insert in each run of duct.	Insert Marker Cap: Zinc Screw Brass Screw	DMC-Z DMC-B			
			Reducing Bushing		Reduces threaded 2" IPS insert opening to either 3/4" NPT or 1" NPT threaded opening for attachment of conduit fitting or pedestal fitting chase nipple.	2" to 3/4"	RB-162
						2" to 1"	RB-163



# Hubbell Underfloor Duct Series

## Underfloor Duct Raceway Activation Kits



- Available in brass and brushed aluminum to meet aesthetic requirements
- Available in one, two and three-gang options
- ScrubShield® Complies with UL514A scrub water requirements
- Flanged design may be used in tile, wood, carpet, terrazzo and bare concrete applications
- Uniform look when used in same areas where Hubbell floor boxes are installed.

	Flush Insert Underfloor Duct	Finish	1-Gang 6" x 4.85"	2-Gang 6" x 8.13"	3-Gang 6" x 11.34"	
Flanges	Flanges are provided with adapter plates and accessories required for installing to rectangular Underfloor Duct preset inserts and aftersets.	Brass	<b>SB3083W-UFD</b>	<b>SB3084W-UFD</b>	<b>SB3085W-UFD</b>	
		Aluminum	<b>SA3083W-UFD</b>	<b>SA3084W-UFD</b>	<b>SA3085W-UFD</b>	
Covers All Covers 4.15" x 2.99"						
		Duplex Flap		Duplex Screw	Style Line Decorator Opening	Combination 2 1/8" x 3/4"
		Brass	<b>S3825</b>	<b>S3625</b>	<b>S3826</b>	<b>S2425</b>
		Aluminum	<b>SA3825</b>	<b>SA3625</b>	<b>SA3826</b>	<b>SA2425</b>
			Combination 2 1/8" x 1"	2 1/8" Single Receptacle	2 3/8" Single Receptacle	Blank
		Brass	<b>S2625</b>	<b>S2825</b>	<b>S3425</b>	<b>S3813</b>
	Aluminum	<b>SA2625</b>	—	—	<b>SA3813</b>	

Round Insert Underfloor Duct							
Housing	Die-cast aluminum frame, brushed aluminum housing, chase nipple, without plates		1" Chase Nipple	<b>SC3099A</b>			
			3/4" Chase Nipple	<b>SC3098A</b>			
Plates	Duplex Receptacle	Single Receptacle 1.39 in. (35.3 mm) opening	Style Line Decorator	Blank	Telephone bushing 1 in. I.D. and (2) 3/8" KO for coax	Furniture Feed aluminum plate with 3/4" trade size KO	Furniture Feed aluminum plate, blank
		<b>SS309D</b>	<b>SS309S</b>	<b>SS309DS</b>	<b>SS309B</b>	<b>SS309T</b>	<b>SS309SF</b>

**HUBBELL®**  
Wiring Device-Kellems

[www.hubbell-wiring.com](http://www.hubbell-wiring.com)

