

## Adjustable Non-Metallic Concrete Floor Box Stand

- For use with Hubbell concrete floor boxes
- For slab on-grade, second floor and above installations
- Allows floor boxes to be installed in deeper concrete pours
- Adjustment range 2.5 inch to 4.0 inch
- Molded PVC construction



### FEATURES

- Designed to be used with Hubbell RF400, PFB1, CFBS1R4PFB and S1PFB concrete floor boxes.
- 6 inch round flat pedestal surface for installation efficiency.
- Bond with standard PVC glue.
- Easy to read marking on leveling legs.
- Independent adjusting leveling legs with a 2.5 inch to 4.0 inch adjustable range.



- Adjust leveling legs to rough installation height. Apply standard PVC glue per manufacturer's instructions.

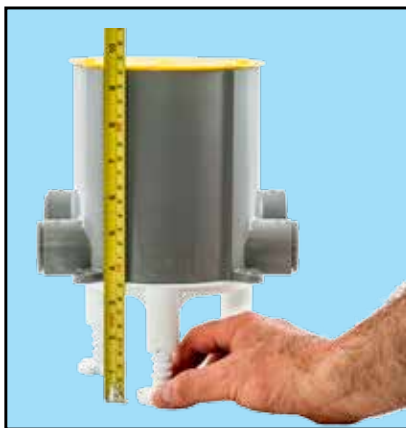

- Install floor box on to PFBSTAND. After PVC glue is set, adjust leveling legs to set box to desired height.



- Adjust leveling legs to level top of box.

# Hubbell SystemOne

## Adjustable Non-Metallic Concrete Floor Box Stand

### Adjustable Non-Metallic Concrete Floor Box Stand

Description	Color	Catalog Number
Floor box stand.	White	<b>PFBSTAND</b>

### Dimensions

Diameter	6 in.
Height Adjustment	2.5 in. to 4 in.
Leg Base Diameter	1.5 in.



**PFBSTAND**

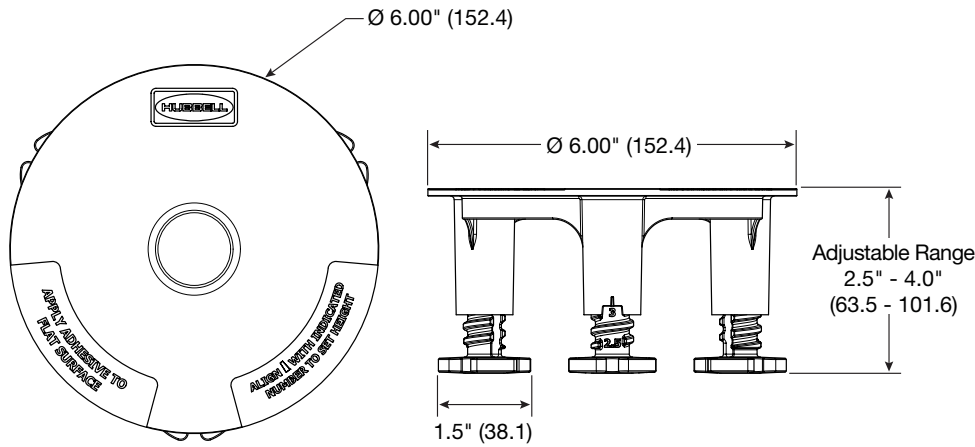

### Featuring Hubbell Delivery Systems

Businesses today require a more intelligent and connected way of communicating than ever before. To support their ever-changing, ever-expanding requirements, Hubbell Delivery Systems products bring power, data, and audio/video solutions to wherever they're needed within a building. You've never had so many customized options for getting power, data, and AV from point A to point B: in or above the floor, through the floor, ceiling to floor, along the wall, or in the wall or ceiling. Hubbell product solutions revolutionize the way power, data, and AV are delivered.



**In the Floor/  
Above the Floor**

 Hubbell's flush and recessed floor boxes accommodate the industry's broadest range of power, data and AV applications in a single location.



**Through the Floor**  
 In all types of environments – even in raised-floor installations – bringing power, data and AV through the floor allows end-users to reconfigure with minimal downtime.



**Ceiling to Floor**  
 Attractive, durable, customizable power poles effectively distribute power, fiber and data cabling from the ceiling to the floor.

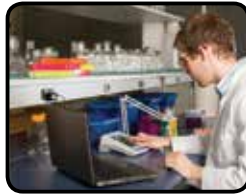

**In and Along the Wall**  
 Wall ducts, non-metallic and metal raceway delivery options feature mounted outlets, designed for enclosure of power and data cabling.



**In the Wall or Ceiling**  
 Hubbell's in-wall and in-ceiling power, data and AV solutions ranging from ceiling boxes and large capacity wall boxes to flat panel TV enclosures.



**On the Surface**  
 Table top and work surface boxes bring power, AV and charging solutions to the places it's needed most.