



Features

- Patented AUTOGUARD® self test technology
- Internal back wiring clamp and guide for quick and secure termination
- Triple wipe construction

Ordering Information

Description	Color	UPC	Catalog Number
15A, 125V, Style Line®, AUTOGUARD® self test GFCI receptacle, flush face, back and side wired, multiple drive screws	Light Almond	883778122057	GFRST15LA



Listings

UL Listed - Canadian and U.S.
Meets ADA Standards
Meets all NEC® requirements
CSA Certified
NEMA® WD-6 Compliant

Specifications

Face	Nylon
Base	Nylon
Power Contacts	Brass
Ground Contacts	Brass
Mounting Strap	Zinc plated steel
Mounting Screws	Zinc plated steel

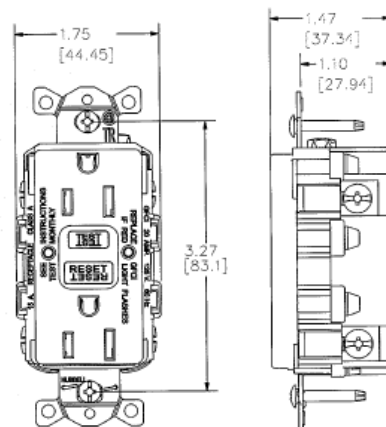

Online Resources

[Customer Use Drawing](#)
[eCatalog](#)
[Installation Instructions](#)