

# Ground Fault Products Commercial Tamper-Resistant and Weather Resistant GFCI Receptacles

# HUBBELL



## Features

- Patented shutter design for tamper-resistant protection
- Meets NEC requirements for TR (517-18c) and WR (406.9), UV and corrosion resistance for harsh and damp applications
- Patented AUTOGUARD® self test technology
- Protects against line and load reversal, no power to the face or downstream if device is miswired

## Ordering Information

Description	Color	UPC	Catalog Number
20A, 125V, Style Line®, assembled in the USA, AUTOGUARD® self test GFCI receptacle, tamper-resistant and weather resistant, flush face, back and side wired, multiple drive screws	Ivory	883778124389	GFTWRST20IU

## Listings

UL Listed - Canadian and U.S.  
Meets ADA Standards  
Meets all NEC® requirements  
CSA Certified  
NEMA® WD-6 Compliant

## Specifications

Face	Nylon
Base	Nylon
Power Contacts	Brass
Ground Contacts	Brass
Mounting Strap	Zinc plated steel
Mounting Screws	Zinc plated steel

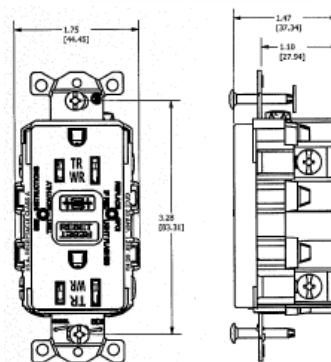

## Online Resources

[Customer Use Drawing](#)  
[eCatalog](#)  
[Installation Instructions](#)

Dimensions in Inches (mm)

Hubbell Wiring Device-Kellems • Hubbell Incorporated (Delaware) • 40 Waterview Drive • Shelton, CT 06484

Phone (800) 288-6000 • Fax (800) 255-1031 • Specifications subject to change without notice.

